

HCH/ATEX

Extremely robust, wall mounted axial fans, with ATEX 2G or 2D certification and Ex db, Ex eb or Ex tb motor



Notified authority: LOM
 Identification no.: LOM 03ATEX0157
 Motor marking:
 Ⓜ II 2G Ex db IIB T4 Gb
 Ⓜ II 2G Ex eb IIB T3 Gb
 Ⓜ II 2D Ex tb IIIC T135 °C Db



Circular axial fans and ATEX 2G or 2D certification with flameproof Ex db, increased safety Ex eb or dust ignition proof Ex tb motor to work in explosive gas or dust atmospheres.

Fan:

- Support ring in sheet steel, with aluminum band in the propeller area according to EN 14986 standard.
- Cast aluminium impellers.
- Airflow direction from motor to impeller.
- Standard marking with flameproof motor (Ex db): II 2G Ex h IIB T4 Gb.
- Standard marking with increased safety motor (Ex eb): II 2G Ex h IIB T3 Gb.
- Standard marking with motor for dust ignition proof (Ex tb): II 2D Ex h IIIC T135 °C Db.

Motor:

- Class F motors with ball bearings and ATEX certification flameproof Ex db, increased safety Ex eb or dust ignition proof Ex tb.

- Three-phase 230/400 V 50 Hz (up to 4 kW) and 400/690 V 50 Hz (powers greater than 4 kW).
- Working temperature: -20 °C +40 °C.

Finish:

- Anti-corrosive with ATEX paint, free of iron components, in polyester resin polymerized at 190 °C, after degreasing with phosphate-free nanotechnological treatment.

On request:

- Motors with built-in PTC.
- Special windings for different voltages and frequencies.
- ATEX construction for flammable dust.
- ATEX fan with greater protection than the standard marking.
- Fans with 2 speed motor.
- Ex db flameproof single-phase motors.

Order code

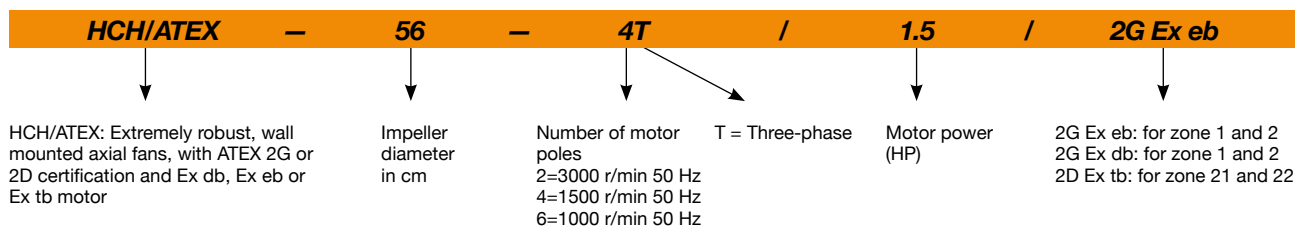

Technical characteristics

Model	Speed (r/min)	Maximum admissible current (A)			Installed power (kW)	Maximum flow rate (m³/h)	Sound pressure level¹ dB (A)		Approx. weight (Kg)	
		230V	400V	690V			Inlet	Ex eb	Ex db	
HCH/ATEX-35-2T	2770	1.62	0.93		0.37	5885	67	13	23	
HCH/ATEX-35-4T	1400	1.28	0.74		0.12	3210	49	12	19	
HCH/ATEX-40-2T-1.5	2850	3.93	2.26		1.10	8805	74	27	40	
HCH/ATEX-40-4T-0.33	1370	1.25	0.72		0.25	5175	54	21	30	
HCH/ATEX-45-4T-0.5	1370	2.60	1.50		0.37	7100	59	25	33	
HCH/ATEX-56-4T-0.75	1410	2.87	1.65		0.55	11040	65	32	46	
HCH/ATEX-56-4T-1	1410	3.81	2.20		0.75	12940	66	34	47	
HCH/ATEX-56-4T-1.5	1410	4.54	2.61		1.10	13995	67	36	55	
HCH/ATEX-56-4T-2	1400	6.93	4.00		1.50	15290	68	39	59	
HCH/ATEX-56-6T-0.33	910	2.42	1.40		0.25	8500	54	31	39	
HCH/ATEX-56-6T-0.5	935	2.77	1.60		0.37	9300	54	34	43	
HCH/ATEX-56-6T-0.75	930	3.46	2.00		0.55	9995	55	34	47	
HCH/ATEX-63-4T-1	1410	3.81	2.20		0.75	14145	68	43	56	

Technical characteristics

Model	Speed (r/min)	Maximum admissible current (A)			Installed power (kW)	Maximum flow rate (m³/h)	Sound pressure level¹ dB (A)		Approx. weight (Kg)	
		230V	400V	690V			Inlet	Ex eb	Ex db	
HCH/ATEX-63-4T-1.5	1410	4.54	2.61		1.10	17020	69	45	64	
HCH/ATEX-63-4T-2	1400	6.93	4.00		1.50	18910	70	48	68	
HCH/ATEX-63-4T-3	1410	8.30	4.77		2.20	22090	71	53	76	
HCH/ATEX-63-4T-4	1440	11.27	6.48		3.00	25390	72	56	79	
HCH/ATEX-63-6T-0.5	935	2.77	1.60		0.37	12135	59	43	52	
HCH/ATEX-63-6T-0.75	930	3.46	2.00		0.55	12760	60	43	56	
HCH/ATEX-71-4T-1.5	1410	4.54	2.61		1.10	19770	73	51	70	
HCH/ATEX-71-4T-2	1400	6.93	4.00		1.50	21090	74	54	74	
HCH/ATEX-71-4T-3	1410	8.30	4.77		2.20	23970	76	60	83	
HCH/ATEX-71-4T-4	1440	11.27	6.48		3.00	29410	77	63	86	
HCH/ATEX-71-6T-0.75	930	3.46	2.00		0.55	15130	62	49	62	
HCH/ATEX-71-6T-1	930	4.16	2.40		0.75	17260	63	51	70	
HCH/ATEX-71-6T-1.5	910	5.89	3.40		1.10	20965	64	54	75	
HCH/ATEX-80-4T-3	1410	8.30	4.77		2.20	27940	77	69	92	
HCH/ATEX-80-4T-4	1440	11.27	6.48		3.00	32720	78	72	95	
HCH/ATEX-80-4T-5.5	1450	15.29	8.79		4.00	37440	79	74	98	
HCH/ATEX-80-6T-1	930	4.16	2.40		0.75	20560	66	60	79	
HCH/ATEX-80-6T-1.5	910	5.89	3.40		1.10	24650	67	63	84	
HCH/ATEX-80-6T-2	940	7.62	4.40		1.50	27960	68	71	95	
HCH/ATEX-80-6T-3	940	9.35	5.40		2.20	32545	69	74	98	
HCH/ATEX-90-4T-4	1440	11.27	6.48		3.00	37635	83	87	110	
HCH/ATEX-90-4T-5.5	1450	15.29	8.79		4.00	41810	85	90	114	
HCH/ATEX-90-4T-7.5	1440		10.64	18.50	5.50	47550	87	103	142	
HCH/ATEX-90-4T-10	1450		14.39	25.03	7.50	53120	88	111	145	
HCH/ATEX-90-6T-3	940	9.35	5.40		2.20	35555	74	90	114	
HCH/ATEX-90-6T-4	945	14.72	8.50		3.00	40165	75	102	142	
HCH/ATEX-100-4T-7.5	1440		10.64	18.50	5.50	52470	90	115	154	
HCH/ATEX-100-4T-10	1450		14.39	25.03	7.50	58560	91	122	156	
HCH/ATEX-100-4T-15	1460		20.76	36.10	11.00	68000	92	159	256	
HCH/ATEX-100-4T-20	1450		28.19	49.03	15.00	71850	93	178	279	
HCH/ATEX-100-6T-3	940	9.35	5.40		2.20	40390	80	101	125	
HCH/ATEX-100-6T-4	945	14.72	8.50		3.00	46960	81	113	153	
HCH/ATEX-100-6T-5.5	950	18.88	10.90		4.00	52025	82	120	156	

1. The noise level values are pressures in dB(A) measured at a distance of 3 metres in a free field.

Acoustic characteristics

Sound power spectrum Lw(A) in dB(A) per Hz frequency band
Values measured at inlet with maximum flow rate

	63	125	250	500	1000	2000	4000	8000		63	125	250	500	1000	2000	4000	8000
HCH/ATEX-35-2T	48	63	82	81	82	81	76	67	HCH/ATEX-71-6T-0.75	44	64	72	77	79	76	69	58
HCH/ATEX-35-4T	30	45	64	63	64	63	58	49	HCH/ATEX-71-6T-1	45	65	73	78	80	77	70	59
HCH/ATEX-40-2T-1.5	55	70	89	88	89	88	83	74	HCH/ATEX-71-6T-1.5	46	66	74	79	81	78	71	60
HCH/ATEX-40-4T-0.33	35	50	69	68	69	68	63	54	HCH/ATEX-80-4T-3	59	79	87	92	94	91	84	73
HCH/ATEX-45-4T-0.5	33	50	62	70	75	75	71	64	HCH/ATEX-80-4T-4	60	80	88	93	95	92	85	74
HCH/ATEX-56-4T-0.75	47	67	75	80	82	79	72	61	HCH/ATEX-80-4T-5.5	61	81	89	94	96	93	86	75
HCH/ATEX-56-4T-1	48	68	76	81	83	80	73	62	HCH/ATEX-80-6T-1	48	68	76	81	83	80	73	62
HCH/ATEX-56-4T-1.5	49	69	77	82	84	81	74	63	HCH/ATEX-80-6T-1.5	49	69	77	82	84	81	74	63
HCH/ATEX-56-4T-2	50	70	78	83	85	82	75	64	HCH/ATEX-80-6T-2	50	70	78	83	85	82	75	64
HCH/ATEX-56-6T-0.33	36	56	64	69	71	68	61	50	HCH/ATEX-80-6T-3	51	71	79	84	86	83	76	65
HCH/ATEX-56-6T-0.5	36	56	64	69	71	68	61	50	HCH/ATEX-90-4T-4	65	86	93	98	101	97	90	79
HCH/ATEX-56-6T-0.75	37	57	65	70	72	69	62	51	HCH/ATEX-90-4T-5.5	67	88	95	100	103	99	92	81
HCH/ATEX-63-4T-1	50	70	78	83	85	82	75	64	HCH/ATEX-90-4T-7.5	69	90	97	102	105	101	94	83
HCH/ATEX-63-4T-1.5	51	71	79	84	86	83	76	65	HCH/ATEX-90-4T-10	70	91	98	103	106	102	95	84
HCH/ATEX-63-4T-2	52	72	80	85	87	84	77	66	HCH/ATEX-90-6T-3	56	77	84	89	92	88	81	70
HCH/ATEX-63-4T-3	53	73	81	86	88	85	78	67	HCH/ATEX-90-6T-4	57	78	85	90	93	89	82	71
HCH/ATEX-63-4T-4	54	74	82	87	89	86	79	68	HCH/ATEX-100-4T-7.5	72	92	100	105	107	104	97	86
HCH/ATEX-63-6T-0.5	41	61	69	74	76	73	66	55	HCH/ATEX-100-4T-10	73	93	101	106	108	105	98	87
HCH/ATEX-63-6T-0.75	42	62	70	75	77	74	67	56	HCH/ATEX-100-4T-15	74	94	102	107	109	106	99	88
HCH/ATEX-71-4T-1.5	55	75	83	88	90	87	80	69	HCH/ATEX-100-4T-20	75	95	103	108	110	107	100	89
HCH/ATEX-71-4T-2	56	76	84	89	91	88	81	70	HCH/ATEX-100-6T-3	62	82	90	95	97	94	87	76
HCH/ATEX-71-4T-3	58	78	86	91	93	90	83	72	HCH/ATEX-100-6T-4	63	83	91	96	98	95	88	77
HCH/ATEX-71-4T-4	59	79	87	92	94	91	84	73	HCH/ATEX-100-6T-5.5	64	84	92	97	99	96	89	78

Dimensions mm

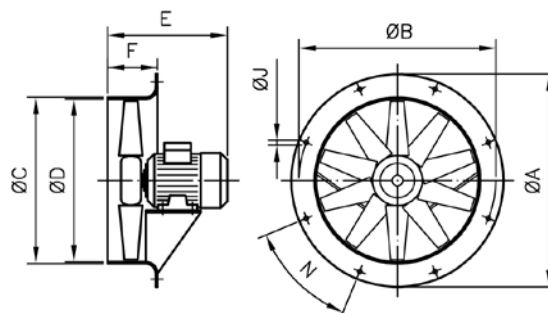

	Motor size	ØA	ØB	ØC	ØD	E	F	ØJ	N	
	HCH/ATEX-35	71	425	395	358	355	279	110	8x45°	
	HCH/ATEX-35	63	425	395	358	355	279	110	8x45°	
	HCH/ATEX-35	56	425	395	358	355	279	110	8x45°	
	HCH/ATEX-40	71	490	450	414	410	305	120	8x45°	
	HCH/ATEX-40	80	490	450	414	410	342	120	8x45°	
	HCH/ATEX-45	71	540	500	464	460	295	120	8x45°	
	HCH/ATEX-56	80	660	620	564	560	326	120	12x30°	
	HCH/ATEX-56	90S	660	620	564	560	389	120	12x30°	
	HCH/ATEX-56	90L	660	620	564	560	389	120	12x30°	
	HCH/ATEX-56	71	660	620	564	560	317	120	12x30°	
	HCH/ATEX-63	80	730	690	645	640	337	150	12x30°	
	HCH/ATEX-63	90S	730	690	645	640	396	150	12x30°	
	HCH/ATEX-63	90L	730	690	645	640	396	150	12x30°	
	HCH/ATEX-63	100L	730	690	645	640	419	150	12x30°	
	HCH/ATEX-71	90S	810	770	715	710	397	150	12	16x22°30'
	HCH/ATEX-71	90L	810	770	715	710	397	150	12	16x22°30'
	HCH/ATEX-71	100L	810	770	715	710	424	150	12	16x22°30'
	HCH/ATEX-71	80	810	770	715	710	334	150	12	16x22°30'
	HCH/ATEX-80	100L	900	860	805	800	432	180	12	16x22°30'
	HCH/ATEX-80	112M	900	860	805	800	455	180	12	16x22°30'
	HCH/ATEX-80	90S	900	860	805	800	414	180	12	16x22°30'
	HCH/ATEX-80	90L	900	860	805	800	414	180	12	16x22°30'
	HCH/ATEX-90	100L	1015	970	906	900	477	180	15	16x22°30'
	HCH/ATEX-90	112M	1015	970	906	900	458	180	15	16x22°30'
	HCH/ATEX-90	132S	1015	970	906	900	572	180	15	16x22°30'
	HCH/ATEX-90	132M	1015	970	906	900	512	180	15	16x22°30'
	HCH/ATEX-100	132S	1115	1070	1006	1000	579	200	15	16x22°30'
	HCH/ATEX-100	132M	1115	1070	1006	1000	518	200	15	16x22°30'
	HCH/ATEX-100	112M	1115	1070	1006	1000	438	200	15	16x22°30'
	HCH/ATEX-100	160M	1115	1070	1006	1000	608	200	15	16x22°30'
	HCH/ATEX-100	160L	1115	1070	1006	1000	652	200	15	16x22°30'

The measurements correspond to Ex eb motor.

Motor build sizes depending on power (1 speed)

	HP													
	0.13	0.33	0.5	0.75	1	1.5	2	3	4	5.5	7.5	10	15	20
2T (3000 r/min)	56	63	71	71	80	80	90S	90L	100L	112M	132S	132S	160M	160M
4T (1500 r/min)	56	71	71	80	80	90S	90L	100L	100L	112M	132S	132M	160M	160L
6T (1000 r/min)	63	71	80	80	90S	90L	100L	112M	132S	132M	132M	160M	160L	180L

Characteristic curves

Q= Flow rate in m³/h, m³/s and cfm

Pe= Static pressure in mm H₂O, Pa and inWG

2T=3000 r/min

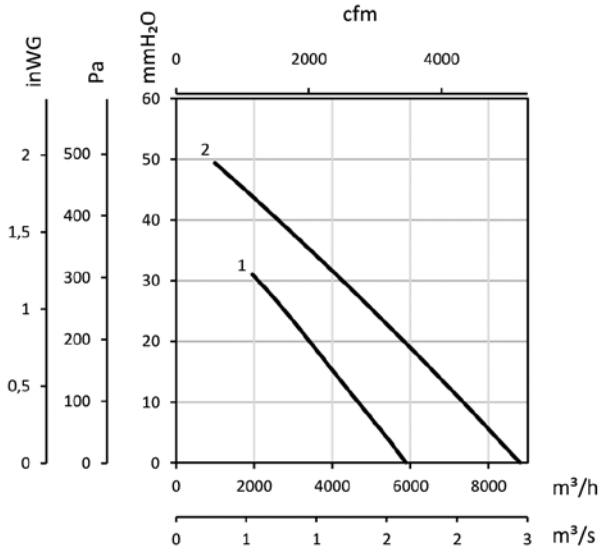

1 : HCH/ATEX-35-2T
2 : HCH/ATEX-40-2T-1.5

4T=1500 r/min

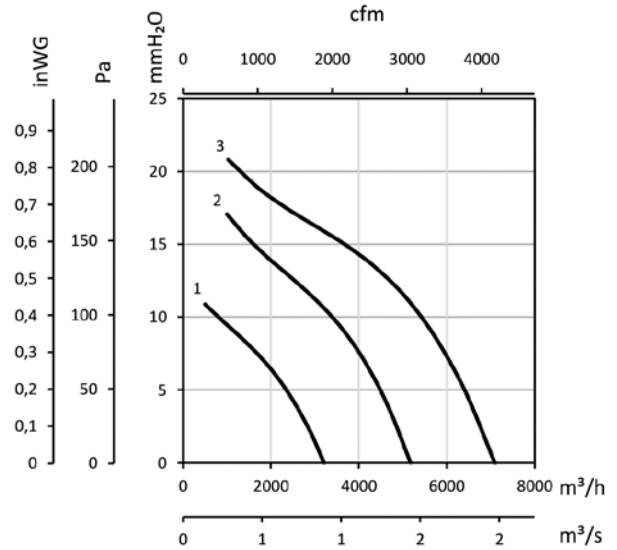

1 : HCH/ATEX-35-4T
2 : HCH/ATEX-40-4T-0.33
3 : HCH/ATEX-45-4T-0.5

4T=1500 r/min

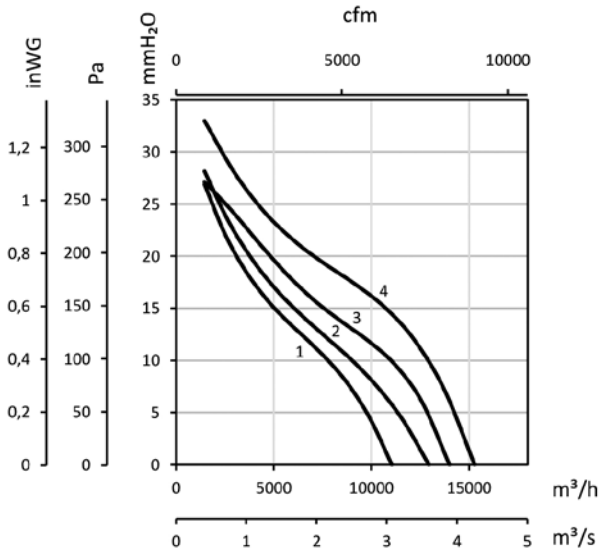

1 : HCH/ATEX-56-4T-0.75
2 : HCH/ATEX-56-4T-1
3 : HCH/ATEX-56-4T-1.5
4 : HCH/ATEX-56-4T-2

4T=1500 r/min

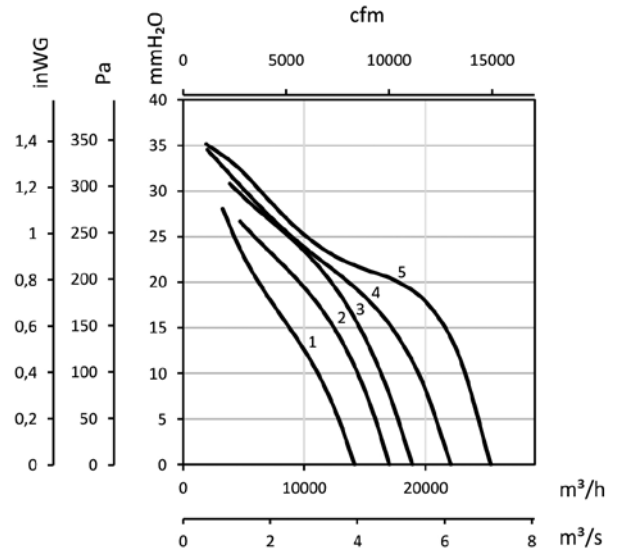

1 : HCH/ATEX-63-4T-1
2 : HCH/ATEX-63-4T-1.5
3 : HCH/ATEX-63-4T-2
4 : HCH/ATEX-63-4T-3
5 : HCH/ATEX-63-4T-4

Characteristic curves

Q= Flow rate in m³/h, m³/s and cfm

Pe= Static pressure in mm H₂O, Pa and inwg

4T=1500 r/min

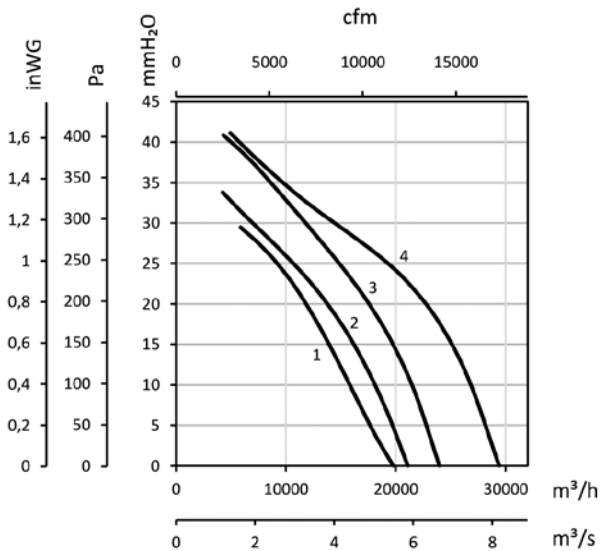

- 1 : HCH/ATEX-71-4T-1.5
- 2 : HCH/ATEX-71-4T-2
- 3 : HCH/ATEX-71-4T-3
- 4 : HCH/ATEX-71-4T-4

4T=1500 r/min

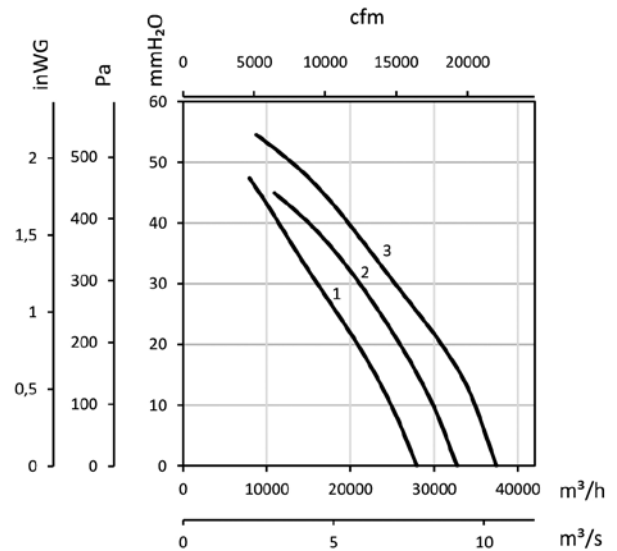

- 1 : HCH/ATEX-80-4T-3
- 2 : HCH/ATEX-80-4T-4
- 3 : HCH/ATEX-80-4T-5.5

4T=1500 r/min

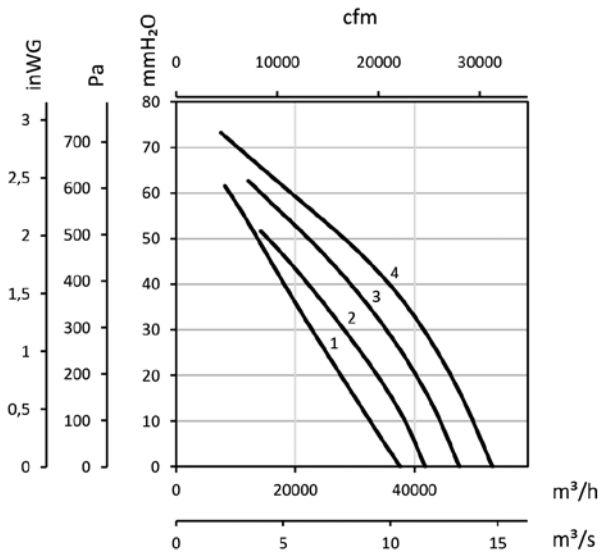

- 1 : HCH/ATEX-90-4T-4
- 2 : HCH/ATEX-90-4T-5.5
- 3 : HCH/ATEX-90-4T-7.5
- 4 : HCH/ATEX-90-4T-10

4T=1500 r/min

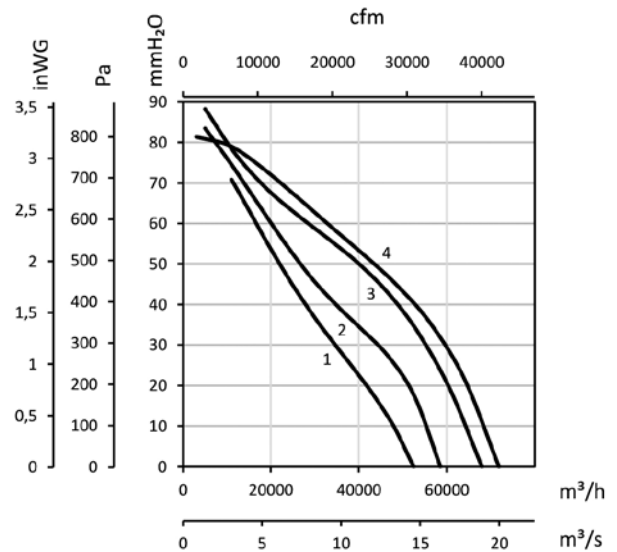

- 1 : HCH/ATEX-100-4T-7.5
- 2 : HCH/ATEX-100-4T-10
- 3 : HCH/ATEX-100-4T-15
- 4 : HCH/ATEX-100-4T-20

Characteristic curves

Q= Flow rate in m³/h, m³/s and cfm

Pe= Static pressure in mm H₂O, Pa and inwg

6T=1000 r/min

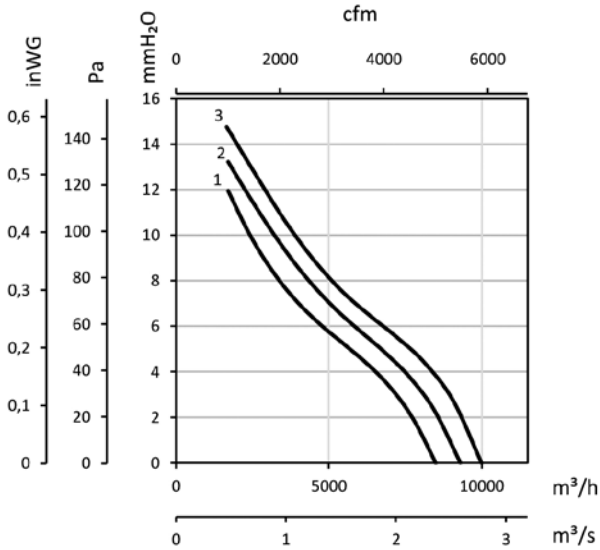

1 : HCH/ATEX-56-6T-0.33
2 : HCH/ATEX-56-6T-0.5
3 : HCH/ATEX-56-6T-0.75

6T=1000 r/min

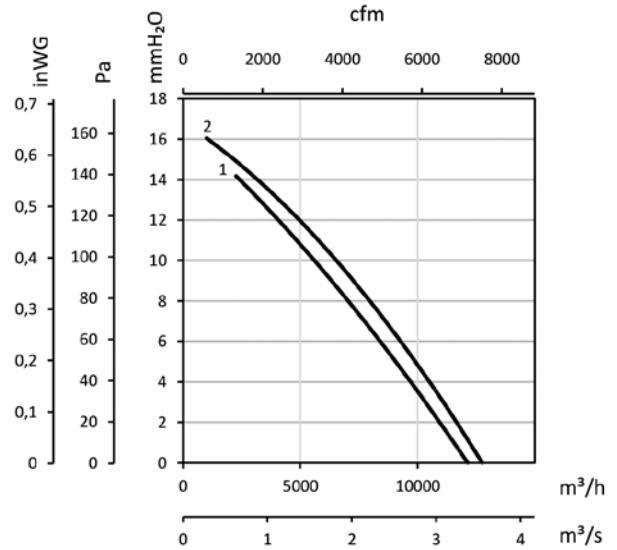

1 : HCH/ATEX-63-6T-0.5
2 : HCH/ATEX-63-6T-0.75

6T=1000 r/min

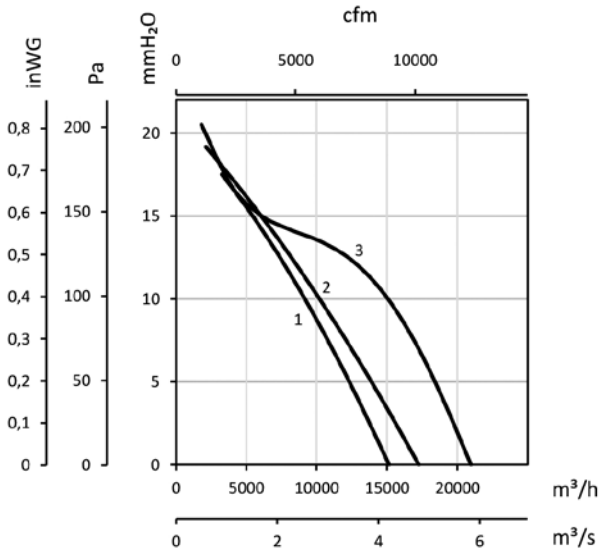

1 : HCH/ATEX-71-6T-0.75
2 : HCH/ATEX-71-6T-1
3 : HCH/ATEX-71-6T-1.5

6T=1000 r/min

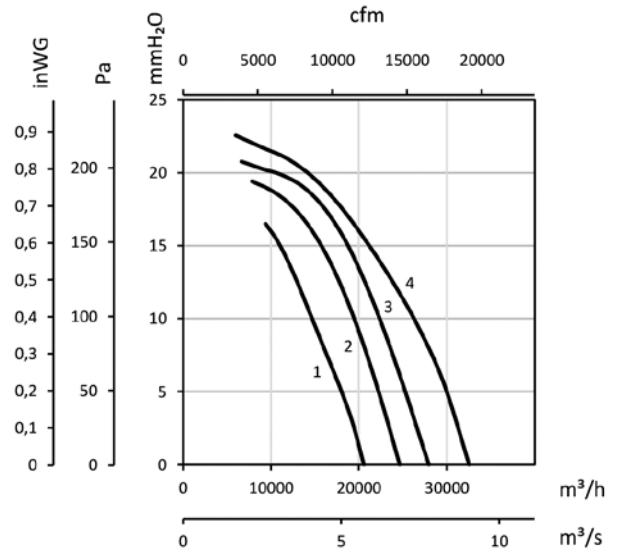

1 : HCH/ATEX-80-6T-1
2 : HCH/ATEX-80-6T-1.5
3 : HCH/ATEX-80-6T-2
4 : HCH/ATEX-80-6T-3

Characteristic curves

Q= Flow rate in m³/h, m³/s and cfm

Pe= Static pressure in mm H₂O, Pa and inwg

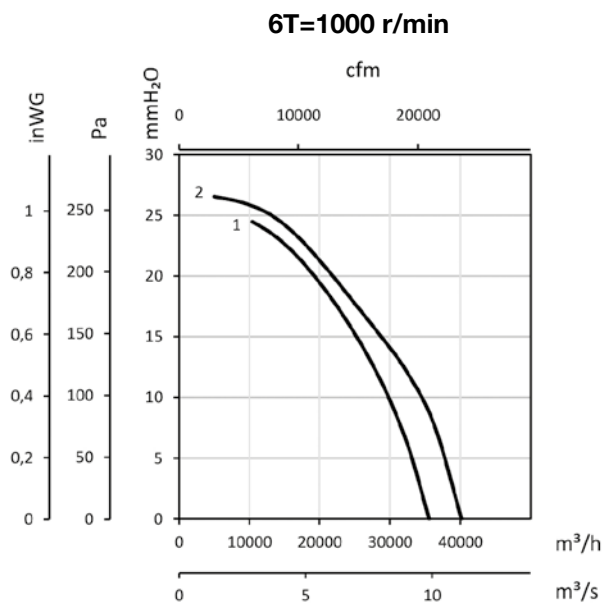

1 : HCH/ATEX-90-6T-3
2 : HCH/ATEX-90-6T-4

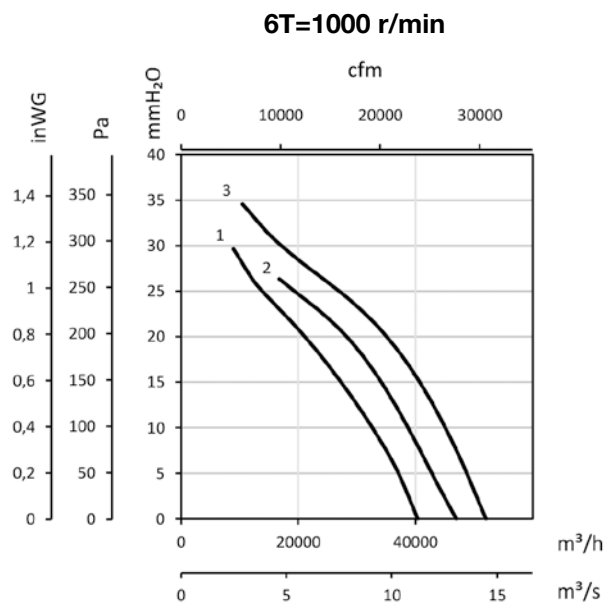

1 : HCH/ATEX-100-6T-3
2 : HCH/ATEX-100-6T-4
3 : HCH/ATEX-100-6T-5.5

Accessories



INT/ATEX



P



R

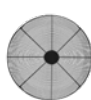

RI



PV



BTUB



PT



PT/H