

RFHD



Centrifugal roof fans with horizontal outlet and ATEX Ex d certification

Centrifugal roof fans with horizontal air outlet and hood in aluminium. ATEX certification and CEE ExII2G Ex d flame-resistant to work in explosive atmospheres.



Ex "d" marked: $\text{CE} \text{ Ex II 2G Ex d}$
 Notified authority: L.O.M
 Identification No:
 LOM03ATEX0147

Fan:

- Base support in galvanised steel with inlets made from brass according to standard EN-14986:2007
- Impeller with backward-curved blades made from galvanised sheet steel
- Bird guard
- Aluminium rain deflector hood

Motor:

- Class F motors with ball bearings and ATEX certification, Ex d II B T4 Gb flame-resistant
- Three phase, 50Hz, 230/400V motors up to and including 4kW. 400/690V over 4kW
- Max. air temperature to transport: -20 °C+ 80 °C

Finish:

- Anticorrosive galvanised sheet steel and aluminium

On request:

- Built-in motors with PTC.
- Special windings for different electrical supplies and frequencies
- ATEX construction for different categories
- Ex d flame-resistant single-phase motors

Order code

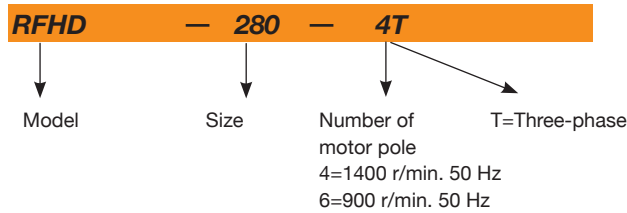

Technical characteristics

Model	Speed (r/min)	Maximum current admissible (A)			Installed power (kW)	Maximum airflow (m ³ /h)	Sound pressure level dB(A)		Approx. weight (Kg)
		230V	400V	690V			Inlet	Outlet	
RFHD-280-4T	1370	2.08	1.20		0.25	1450	37	43	25
RFHD-315-4T	1370	2.08	1.20		0.25	2100	41	47	25
RFHD-315-6T	910	2.42	1.40		0.25	1400	30	36	25
RFHD-355-4T	1370	2.08	1.20		0.25	3100	45	50	32
RFHD-355-6T	910	2.42	1.40		0.25	2000	33	40	33
RFHD-400-4T	1410	2.94	1.70		0.55	4950	48	54	35
RFHD-400-6T	935	2.77	1.60		0.37	3200	37	43	35
RFHD-450-4T	1410	3.81	2.20		0.75	7000	55	61	52
RFHD-450-6T	935	2.77	1.60		0.37	4500	44	50	51
RFHD-500-4T	1400	6.93	4.00		1.50	10200	59	64	60
RFHD-500-6T	935	2.77	1.60		0.37	6900	47	54	53
RFHD-630-6T	910	5.89	3.40		1.10	12000	51	57	95
RFHD-710-6T	940	9.35	5.40		2.20	17300	54	61	118
RFHD-800-6T	950		14.00	8.10	5.50	24700	58	64	160

(1) The sound level values are measurements of pressure in dB(A) at a distance of 6 m and at 2/3 of the maximum airflow (2/3 Qmax.)

Acoustic features

The specified values are determined according to free field measurements of pressure and sound levels in dB(A) at a distance of 6 m.

Sound power Lw(A) spectrum in dB(A) via frequency band in Hz.

Values taken at the inlet with 2/3 of the maximum airflow (2/3Qmax).

Model	63	125	250	500	1000	2000	4000	8000
280-4	35	41	52	55	56	52	50	44
315-4	42	51	56	56	60	59	52	46
315-6	31	40	45	45	49	48	41	35
355-4	46	55	60	60	64	63	56	50
355-6	34	43	48	48	52	51	44	38
400-4	50	56	62	62	65	68	59	53
400-6	39	45	51	51	54	57	48	42
450-4	57	63	69	69	72	75	66	60
450-6	46	52	58	58	61	64	55	49
500-4	62	69	74	74	78	77	70	65
500-6	50	57	62	62	66	65	58	53
630-6	54	60	65	66	70	69	62	55
710-6	57	63	68	69	73	72	65	58
800-6	61	67	72	73	77	76	69	62

Values taken at outlet with 2/3 of the maximum airflow (2/3Qmax).

Model	63	125	250	500	1000	2000	4000	8000
280-4	39	44	58	60	61	61	56	51
315-4	41	50	60	64	67	64	57	51
315-6	30	39	49	53	56	53	46	40
355-4	44	53	63	67	70	67	60	54
355-6	34	43	53	57	60	57	50	44
400-4	49	61	69	71	72	72	64	56
400-6	38	50	58	60	61	61	53	45
450-4	56	68	76	78	79	79	71	63
450-6	45	57	65	67	68	68	60	52
500-4	60	72	80	82	83	80	73	65
500-6	50	62	70	72	73	70	63	55
630-6	50	64	72	76	75	72	66	60
710-6	54	68	76	80	79	76	70	64
800-6	57	71	79	83	72	79	73	67

To obtain the Lwa sound power spectra in dB(A) at the inlet with the maximum airflow (Qmax), add the values in the following tables to the LpA sound pressure level given on the characteristic curves:

Frequency band in Hz								
63	125	250	500	1000	2000	4000	8000	
2	9	15	15	18	18	11	5	

Dimensions in mm

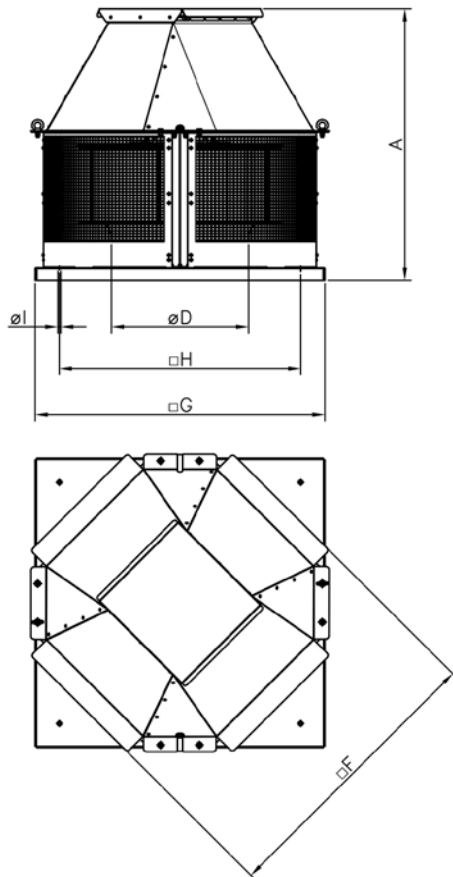

Model	A	ØD*	F	G	H	ØI
RFHD-280	515	250	460	450	360	12
RFHD-315	540	250	460	450	360	12
RFHD-355	610	355	565	560	450	12
RFHD-400	665	355	565	560	450	12
RFHD-450	720	500	735	710	590	12
RFHD-500	755	500	735	710	590	12
RFHD-630	845	630	890	900	750	14
RFHD-710	995	710	1110	1100	900	14
RFHD-800	1065	710	1110	1100	900	14

(*) Recommended nominal diameter for duct.

Characteristic Curves

Q = Airflow in m³/h, m³/s and cfm.

Pe = Static pressure in mmH₂O, Pa and inwg.

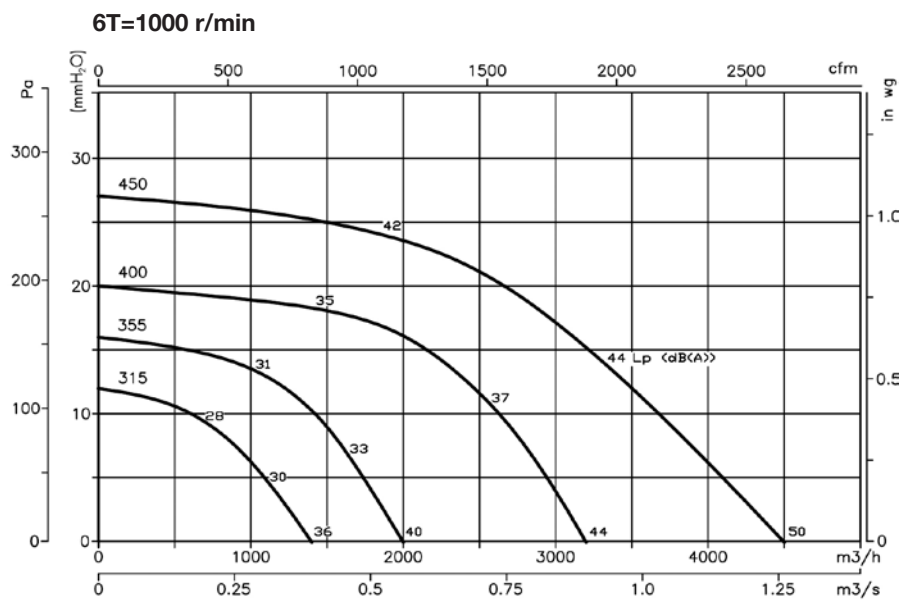
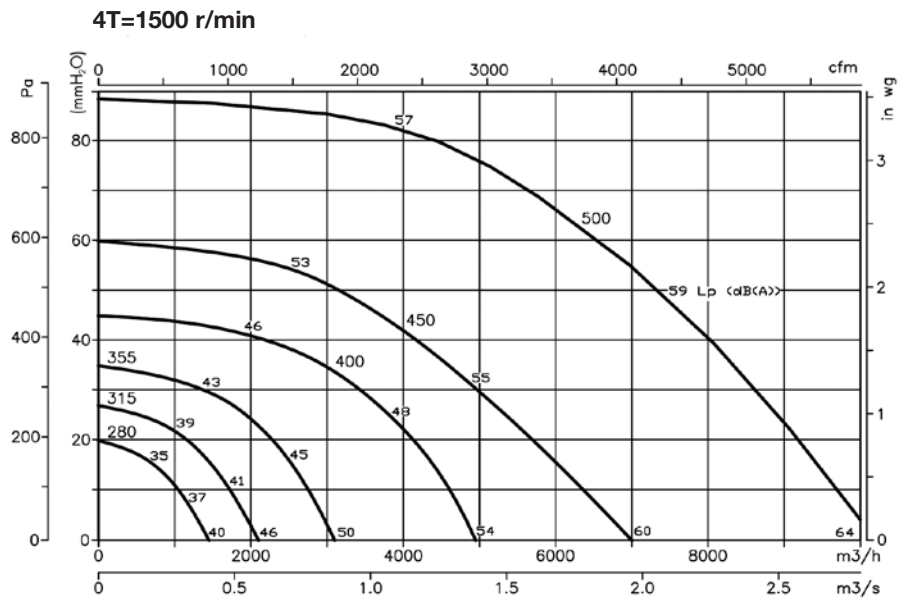

Characteristic Curves

Q = Airflow in m³/h, m³/s and cfm.

Pe= Static pressure in mmH₂O, Pa and inwg.

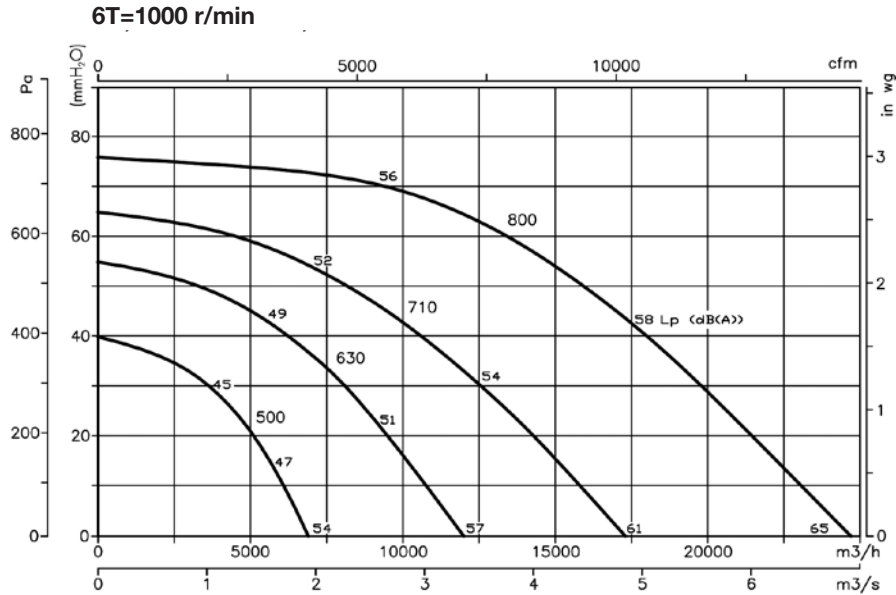

Accessories

See accessories section

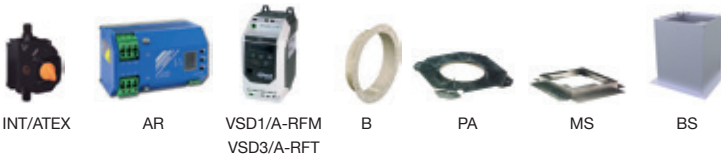

Mounting accessories RFHD

RFHD Fan	Base plate	Support frame	Adaptation plate
280/315	BS-443	MS-443	PA-440/250
355/400	BS-553	MS-553	PA-550
450/500	BS-701	MS-701	PA-700/500
630	BS-891	MS-891	PA-890/630
710/800	BS-1086	MS-1086	PA-1085

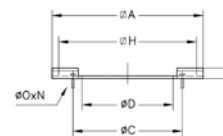
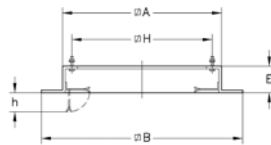
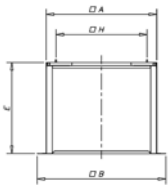

BS. High base plate

	A	B	H	E
BS-443	449	616	360	800
BS-553	554	724	450	800
BS-701	706	876	590	900
BS-891	896	1076	750	900
BS-1086	1092	1272	900	900

MS. Support frame to facilitate assembly

	A	B	E	H	h
MS-443	443	615	60	360	70
MS-553	553	725	60	450	70
MS-701	701	875	60	590	90
MS-891	891	1065	60	750	90
MS-1086	1086	1260	60	900	90

PA. Adaptation plate to mount accessories on roof fans

	A	OC	OD	E	H	OO	N
PA-440/250	440	280	249	20	360	M.6	4x90°
PA-550	550	395	354	20	450	M.6	8x45°
PA-700/500	700	560	499	20	590	M.10	12x30°
PA-890/630	890	690	629	20	750	M.10	12x30°
PA-1085	1088	770	704.5	20	900	M.10	16x22°30'