

THT/CL

400 °C/2h and 300 °C/2h tubular axial extractor fans with long casing and external terminal boxes



Tubular axial extract fans with long casing for immersed operation in fire risk zones.

Fan:

- Tubular casing in sheet steel with external terminal box (Cable box) and inspection hatch.
- Variable angle impeller made of cast aluminium.
- Approved in accordance with standard EN 12101-3, with certifications no.: 0370-CPR-0305 (F400) and 0370-CPR-0973 (F300).
- Airflow direction from motor to impeller.

Motor:

- Class H motors for S1 continuous operation and S2 emergency use. With ball bearings, IP55 protection and 1 or 2 speeds, depending on model.
- Motors with IE3 efficiency for powers equal to or greater than 0.75 kW, except single-phase, 2-speed and 8-pole.
- Three-phase 230/400 V 50 Hz (up to 3 kW) and 400/690 V 50 Hz (powers greater than 3 kW).

- Maximum temperature of air to be carried: S1 -20 °C +40 °C continuous service, also suitable for warm climates with temperatures up to 50 °C. S2 operation, 300 °C/2h, 400 °C/2h.

Finish:

- Anti-corrosive finish in polyester resin, polymerised at 190 °C, after degreasing with phosphate-free nanotechnology treatment.

Available versions:

- THT: tubular axial fans with short casing.

On request:

- Airflow direction from impeller to motor.
- 100% reversible impellers.

Order code

From size 40 to size 100

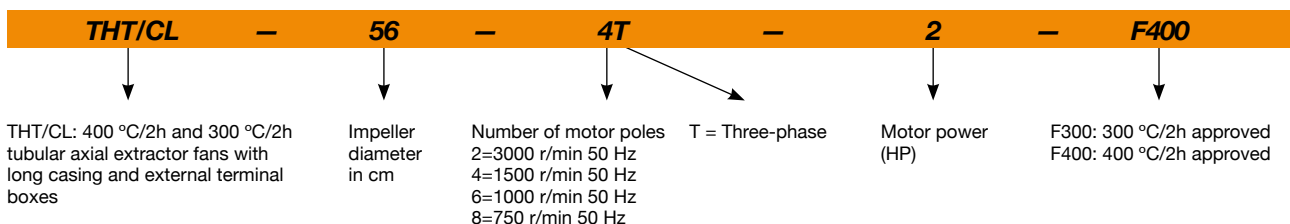

From size 125 to size 160

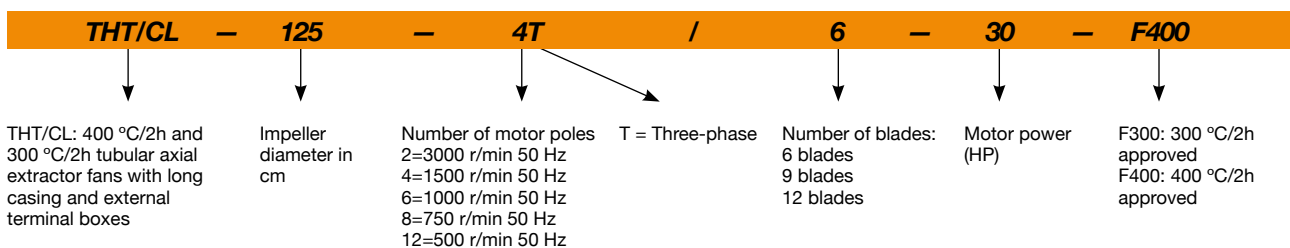

Technical characteristics

Model	Speed (r/min)	Maximum admissible current (A)			Installed power (kW)	Blade tilt angle (°)	Maximum flow rate (m³/h)	Sound pressure level¹ dB (A) Inlet	Approx. weight (Kg)
		230V	400V	690V					
THT/CL-40-2T-1.5 IE3	2880	3.93	2.26		1.10	20	7040	71	33
THT/CL-40-2/4T-1.5	2900 / 1435		2.89 / 1.04		1.10 / 0.25	20	7040 / 3480	71 / 56	34
THT/CL-40-2/4T-2	2940 / 1465		3.58 / 1.19		1.50 / 0.37	24	7950 / 3950	71 / 56	35
THT/CL-40-4T-0.75	1420	2.84	1.64		0.55	32	4800	55	32
THT/CL-40-6T-0.75	930	2.90	1.75		0.55	32	3150	46	37
THT/CL-40-6/12T-0.75	940 / 455		2.35 / 1.15		0.60 / 0.15	32	3150 / 1520	46 / 31	41
THT/CL-45-2T-2 IE3	2880	4.91	2.84		1.50	16	9400	71	38
THT/CL-45-2/4T-2	2940 / 1465		3.58 / 1.19		1.50 / 0.37	16	9400 / 4680	71 / 56	37
THT/CL-45-2T-3 IE3	2900	7.14	4.13		2.20	22	11330	71	39
THT/CL-45-2/4T-3	2930 / 1460		4.79 / 1.54		2.20 / 0.60	22	11330 / 5640	71 / 56	39
THT/CL-45-2T-4 IE3	2855	9.61	5.52		3.00	28	13074	72	49
THT/CL-45-4T-0.75	1420	2.84	1.64		0.55	36	7450	58	34
THT/CL-45-6T-0.75	930	2.90	1.75		0.55	30	4450	48	38
THT/CL-45-6/12T-0.75	940 / 455		2.35 / 1.15		0.60 / 0.15	30	4450 / 2150	48 / 33	42
THT/CL-50-2T-3 IE3	2860	7.14	4.13		2.20	12	11948	76	46
THT/CL-50-2/4T-4	2920 / 1445		6.70 / 2.09		3.00 / 0.80	16	13880 / 6870	76 / 61	51
THT/CL-50-2/4T-6	2930 / 1455		9.50 / 2.80		4.50 / 1.30	20	15900 / 7880	76 / 61	67
THT/CL-50-4T-0.75	1420	2.84	1.64		0.55	22	8390	60	35
THT/CL-50-6T-0.75	930	2.90	1.75		0.55	32	7000	52	40
THT/CL-56-2T-5.5 IE3	2890		7.20	4.17	4.00	16	18800	78	69
THT/CL-56-2/4T-6	2930 / 1455		9.50 / 2.80		4.50 / 1.30	16	18800 / 9320	78 / 63	71
THT/CL-56-2/4T-12	2920 / 1440		18.30 / 5.90		9.00 / 2.50	30	27200 / 13390	79 / 64	137
THT/CL-56-4T-1 IE3	1430	3.08	1.79		0.75	22	11250	63	45
THT/CL-56-4T-1.5 IE3	1440	4.10	2.37		1.10	30	13600	63	44
THT/CL-56-4/8T-1.5	1440 / 705		2.69 / 1.12		1.10 / 0.25	30	13600 / 6640	63 / 48	48
THT/CL-56-4T-2 IE3	1415	5.89	3.38		1.50	36	15030	64	48
THT/CL-56-6T-0.75	930	2.90	1.75		0.55	38	10140	54	44
THT/CL-56-6/12T-0.75	940 / 455		2.35 / 1.15		0.60 / 0.15	38	10140 / 4890	54 / 39	48
THT/CL-63-2T-12 IE3	2950		18.07	10.44	9.20	18	32300	83	161
THT/CL-63-2T-20 IE3	2960		26.50	15.35	15.00	28	39950	82	188
THT/CL-63-4T-1 IE3	1430	3.08	1.79		0.75	14	15190	67	49
THT/CL-63-4T-1.5 IE3	1420	4.10	2.37		1.10	20	17800	66	51
THT/CL-63-4/8T-1.5	1440 / 705		2.69 / 1.12		1.10 / 0.25	20	17800 / 8680	66 / 51	55
THT/CL-63-4T-2 IE3	1425	5.89	3.38		1.50	24	19280	66	55
THT/CL-63-4/8T-2	1415 / 715		3.40 / 1.65		1.50 / 0.30	24	19280 / 9740	66 / 52	70
THT/CL-63-4T-3 IE3	1435	7.86	4.52		2.20	32	22150	68	64
THT/CL-63-4/8T-3	1415 / 700		4.80 / 1.85		2.20 / 0.45	32	22150 / 10920	68 / 53	77
THT/CL-63-4T-4 IE3	1430	11.01	6.33		3.00	38	24240	69	73
THT/CL-63-4/8T-4	1420 / 710		6.45 / 2.28		3.00 / 0.60	38	24240 / 12070	69 / 54	86
THT/CL-63-6T-0.75	930	2.90	1.75		0.55	28	13590	57	51
THT/CL-63-6/12T-0.75	940 / 455		2.35 / 1.15		0.60 / 0.15	28	13590 / 6550	57 / 42	55
THT/CL-63-6T-1 IE3	940	3.36	1.93		0.75	38	15890	58	54
THT/CL-63-6/12T-1	935 / 455		3.75 / 2.76		0.80 / 0.20	38	15890 / 7700	58 / 43	61
THT/CL-71-4T-1.5 IE3	1420	4.10	2.37		1.10	12	19480	71	58
THT/CL-71-4/8T-1.5	1440 / 705		2.69 / 1.12		1.10 / 0.25	12	19480 / 9500	71 / 56	61
THT/CL-71-4T-2 IE3	1425	5.89	3.38		1.50	14	20900	70	61
THT/CL-71-4/8T-2	1415 / 715		3.40 / 1.65		1.50 / 0.30	14	20900 / 10560	70 / 56	76
THT/CL-71-4T-3 IE3	1435	7.86	4.52		2.20	22	25100	70	70
THT/CL-71-4/8T-3	1415 / 700		4.80 / 1.85		2.20 / 0.45	22	25100 / 12370	70 / 55	82
THT/CL-71-4T-4 IE3	1430	11.01	6.33		3.00	28	27480	70	79
THT/CL-71-4/8T-4	1420 / 710		6.45 / 2.28		3.00 / 0.60	28	27480 / 13680	70 / 55	92
THT/CL-71-6T-0.75	930	2.90	1.75		0.55	20	16100	60	57
THT/CL-71-6/12T-0.75	940 / 455		2.35 / 1.15		0.60 / 0.15	20	16100 / 7760	60 / 45	61
THT/CL-71-6T-1 IE3	940	3.36	1.93		0.75	26	17300	60	61
THT/CL-71-6/12T-1	935 / 455		3.75 / 2.76		0.80 / 0.20	26	17300 / 8380	60 / 45	67

Technical characteristics

Model	Speed (r/min)	Maximum admissible current (A)			Installed power (kW)	Blade tilt angle (°)	Maximum flow rate (m³/h)	Sound pressure level¹	Approx. weight (Kg)
		230V	400V	690V				Inlet dB (A)	
THT/CL-71-6T-1.5 IE3	945	4.73	2.72		1.10	34	19930	61	69
THT/CL-71-6/12T-1.5	940 / 460		3.52 / 2.00		1.20 / 0.30	34	19930 / 9760	61 / 46	77
THT/CL-80-4T-3 IE3	1435	7.86	4.52		2.20	12	25450	75	79
THT/CL-80-4/8T-3	1415 / 670		4.80 / 1.85		2.20 / 0.45	12	25450 / 12550	75 / 60	91
THT/CL-80-4T-4 IE3	1430	11.01	6.33		3.00	16	30250	74	88
THT/CL-80-4/8T-4	1420 / 710		6.45 / 2.28		3.00 / 0.60	16	30250 / 15060	74 / 59	101
THT/CL-80-4T-5.5 IE3	1440		7.95	4.61	4.00	18	32750	73	94
THT/CL-80-4/8T-5.5	1450 / 715		7.88 / 2.87		3.80 / 1.00	18	32750 / 16150	73 / 58	127
THT/CL-80-6T-1.5 IE3	945	4.73	2.72		1.10	18	21450	63	78
THT/CL-80-6/12T-1.5	940 / 460		3.52 / 2.00		1.20 / 0.30	18	21450 / 10500	63 / 48	86
THT/CL-80-6T-2 IE3	945	6.25	3.62		1.50	26	25950	64	87
THT/CL-80-6/12T-2	960 / 470		4.46 / 3.43		1.60 / 0.40	26	25950 / 12700	64 / 49	91
THT/CL-80-6T-3 IE3	950	9.78	5.62		2.20	32	29930	65	94
THT/CL-80-6/12T-3	940 / 475		5.62 / 3.32		2.20 / 0.55	32	29930 / 15120	65 / 51	100
THT/CL-80-8T-0.75	700	3.48	2.00		0.55	20	17540	57	71
THT/CL-80-8T-1	710	5.06	2.92		0.75	28	20650	58	78
THT/CL-90-4T-4 IE3	1430	11.01	6.33		3.00	8	33580	79	110
THT/CL-90-4/8T-4	1420 / 710		6.45 / 2.28		3.00 / 0.60	8	33580 / 16720	79 / 64	124
THT/CL-90-4T-5.5 IE3	1440		7.95	4.61	4.00	12	38890	78	117
THT/CL-90-4/8T-5.5	1450 / 715		7.88 / 2.87		3.80 / 1.00	12	38890 / 19170	78 / 63	150
THT/CL-90-4T-7.5 IE3	1430		10.40	6.04	5.50	18	46140	77	143
THT/CL-90-4/8T-7.5	1455 / 725		11.40 / 3.86		5.50 / 1.10	18	46140 / 22910	77 / 62	157
THT/CL-90-4T-10 IE3	1460		14.20	8.17	7.50	22	50140	76	154
THT/CL-90-4/8T-10	1455 / 725		15.10 / 5.16		7.50 / 1.50	22	50140 / 24900	76 / 61	157
THT/CL-90-6T-2 IE3	945	6.25	3.62		1.50	16	28780	66	110
THT/CL-90-6/12T-2	960 / 470		4.46 / 3.43		1.60 / 0.40	16	28780 / 14090	66 / 51	114
THT/CL-90-6T-3 IE3	950	9.78	5.62		2.20	24	34000	66	116
THT/CL-90-6/12T-3	940 / 475		5.62 / 3.32		2.20 / 0.55	24	34000 / 17180	66 / 52	123
THT/CL-90-6T-4 IE3	945	12.80	6.36		3.00	30	38900	69	142
THT/CL-90-6/12T-4	970 / 485		7.37 / 3.53		2.80 / 0.70	30	38900 / 19450	69 / 54	143
THT/CL-90-8T-1	710	5.06	2.92		0.75	18	22900	60	100
THT/CL-90-8T-2	700	7.32	4.21		1.50	30	29490	63	116
THT/CL-90-8T-3	705	9.30	5.35		2.20	32	30850	64	134
THT/CL-100-4T-7.5 IE3	1430		10.40	6.04	5.50	10	46850	82	151
THT/CL-100-4/8T-7.5	1455 / 725		11.40 / 3.86		5.50 / 1.10	10	46850 / 23260	82 / 67	165
THT/CL-100-4T-10 IE3	1460		14.20	8.17	7.50	16	57400	79	162
THT/CL-100-4/8T-10	1455 / 725		15.10 / 5.16		7.50 / 1.50	14	54710 / 27170	80 / 65	165
THT/CL-100-4T-15 IE3	1455		20.70	11.99	11.00	22	66300	79	215
THT/CL-100-4/8T-15	1470 / 730		20.70 / 7.19		11.00 / 3.00	22	66300 / 32880	79 / 64	215
THT/CL-100-4T-20 IE3	1460		27.80	16.03	15.00	28	76150	80	230
THT/CL-100-4/8T-20	1470 / 725		31.72 / 11.75		15.00 / 3.80	28	76150 / 37560	80 / 65	230
THT/CL-100-4T/9-15 IE3	1460		20.70	11.99	11.00	18	55340	80	224
THT/CL-100-4T/9-20 IE3	1460		27.80	16.03	15.00	22	63260	80	239
THT/CL-100-4T/9-25 IE3	1475		35.40	20.39	18.50	26	70625	80	269
THT/CL-100-4T/9-30 IE3	1475		42.20	24.44	22.00	30	74845	82	286
THT/CL-100-6T-3 IE3	950	9.78	5.62		2.20	16	37600	70	124
THT/CL-100-6/12T-3	940 / 475		5.62 / 3.32		2.20 / 0.55	16	37600 / 18990	70 / 56	130
THT/CL-100-6T-4 IE3	945	12.80	6.36		3.00	20	41150	69	150
THT/CL-100-6/12T-4	970 / 485		7.37 / 3.53		2.80 / 0.70	20	41150 / 20580	69 / 54	151
THT/CL-100-6T-5.5 IE3	970		8.37	4.82	4.00	26	47780	70	162
THT/CL-100-6T/9-5.5 IE3	970		11.00	6.35	4.00	20	39020	70	165
THT/CL-100-6T/9-7.5 IE3	970		12.30	7.07	5.50	26	46765	71	173
THT/CL-100-6T/9-10 IE3	970		15.20	8.83	7.50	34	52255	74	213
THT/CL-125-4T/6-20 IE3	1460		27.80	16.03	15.00	10	78600	87	318
THT/CL-125-4/8T/6-20	1470 / 725		31.72 / 11.75		15.00 / 3.80	10	78600 / 38770	87 / 72	318

Technical characteristics

Model	Speed (r/min)	Maximum admissible current (A)			Installed power (kW)	Blade tilt angle (°)	Maximum flow rate (m³/h)	Sound pressure level¹ dB (A) Inlet	Approx. weight (Kg)
		230V	400V	690V					
THT/CL-125-4T/6-25 IE3	1465		35.40	20.39	18.50	14	92550	86	386
THT/CL-125-4/8T/6-27	1470 / 730		39.70 / 14.10		20.00 / 5.00	16	98830 / 48910	85 / 70	400
THT/CL-125-4T/6-30 IE3	1470		42.20	24.44	22.00	16	98830	85	400
THT/CL-125-4/8T/6-37	1475 / 735		54.55 / 18.50		28.00 / 6.50	20	110890 / 55260	85 / 70	481
THT/CL-125-4T/6-40 IE3	1475		53.30	31.02	30.00	22	117450	85	481
THT/CL-125-4T/6-50 IE3	1480		66.80	38.70	37.00	26	131050	85	529
THT/CL-125-4T/6-60 IE3	1475		80.90	46.90	45.00	28	135820	85	599
THT/CL-125-4T/6-75 IE3	1480		98.60	57.20	55.00	34	152100	88	699
THT/CL-125-4T/9-25 IE3	1465		35.40	20.39	18.50	10	79650	87	395
THT/CL-125-4T/9-30 IE3	1470		42.20	24.44	22.00	12	88290	86	409
THT/CL-125-4/8T/9-27	1470 / 730		39.70 / 14.10		20.00 / 5.00	12	88290 / 43690	86 / 71	409
THT/CL-125-4/8T/9-37	1475 / 735		54.55 / 18.50		28.00 / 6.50	16	104040 / 51840	85 / 70	490
THT/CL-125-4T/9-40 IE3	1475		53.30	31.02	30.00	16	104040	85	490
THT/CL-125-4T/9-50 IE3	1480		66.80	38.70	37.00	20	118400	85	538
THT/CL-125-4T/9-60 IE3	1475		80.90	46.90	45.00	24	134970	85	590
THT/CL-125-4T/9-75 IE3	1480		98.60	57.20	55.00	28	146770	86	690
THT/CL-125-4T/9-100 IE3	1480		128.00	74.22	75.00	34	158560	88	829
THT/CL-125-4T/12-50 IE3	1480		66.80	38.70	37.00	18	101660	86	560
THT/CL-125-4T/12-60 IE3	1475		80.90	46.90	45.00	20	109180	86	605
THT/CL-125-4T/12-75 IE3	1480		98.60	57.20	55.00	26	131240	86	705
THT/CL-125-4T/12-100 IE3	1480		128.00	74.22	75.00	32	154100	88	835
THT/CL-125-6T/6-5.5 IE3	970		8.37	4.82	4.00	10	51500	77	251
THT/CL-125-6T/6-7.5 IE3	970		12.30	7.07	5.50	14	60640	75	258
THT/CL-125-6/12T/6-7.5	970 / 480		14.50 / 5.17		5.50 / 1.00	14	60640 / 30010	75 / 60	272
THT/CL-125-6T/6-10 IE3	960		15.20	8.83	7.50	20	72650	74	283
THT/CL-125-6/12T/6-10	970 / 490		13.60 / 5.69		7.20 / 1.80	20	72650 / 36510	74 / 60	303
THT/CL-125-6T/6-15 IE3	955		22.50	13.07	11.00	26	85850	74	313
THT/CL-125-6/12T/6-15	970 / 485		23.10 / 8.41		11.00 / 3.00	26	85850 / 42710	74 / 59	318
THT/CL-125-6T/6-20 IE3	950		29.00	16.78	15.00	30	92850	76	386
THT/CL-125-6/12T/6-24	970 / 480		41.60 / 13.21		17.60 / 2.85	34	99650 / 49320	78 / 63	481
THT/CL-125-6T/9-10 IE3	960		15.20	8.83	7.50	14	63490	77	292
THT/CL-125-6/12T/9-10	970 / 490		13.60 / 5.69		7.20 / 1.80	14	63490 / 31910	77 / 63	312
THT/CL-125-6T/9-15 IE3	955		22.50	13.07	11.00	20	77550	75	322
THT/CL-125-6/12T/9-15	970 / 485		23.10 / 8.41		11.00 / 3.00	20	77550 / 38580	75 / 60	327
THT/CL-125-6T/9-20 IE3	950		29.00	16.78	15.00	26	92950	75	395
THT/CL-125-6/12T/9-24	970 / 480		41.60 / 13.21		17.60 / 2.85	30	98500 / 48750	76 / 61	490
THT/CL-125-6T/9-25 IE3	975		36.10	20.77	18.50	32	101450	77	416
THT/CL-125-6T/9-30 IE3	975		42.30	24.35	22.00	36	106525	80	426
THT/CL-125-6T/12-10 IE3	970		15.20	8.83	7.50	12	49630	79	372
THT/CL-125-6T/12-15 IE3	970		22.50	13.07	11.00	18	67315	77	382
THT/CL-125-6T/12-20 IE3	970		29.00	16.78	15.00	24	81840	76	440
THT/CL-125-6T/12-25 IE3	975		36.10	20.77	18.50	30	96765	77	450
THT/CL-125-6T/12-30 IE3	975		42.30	24.35	22.00	32	102040	78	460
THT/CL-125-6T/12-40 IE3	985		56.00	32.50	30.00	34	106355	79	615
THT/CL-140-6T/6-7.5 IE3	970		12.30	7.07	5.50	8	62800	83	297
THT/CL-140-6T/6-15 IE3	955		22.50	13.07	11.00	16	86640	78	366
THT/CL-140-6T/6-20 IE3	950		29.00	16.78	15.00	22	102950	77	445
THT/CL-140-6T/6-25 IE3	975		36.10	20.77	18.50	24	108750	77	497
THT/CL-140-6T/6-30 IE3	975		42.30	24.35	22.00	28	119050	77	506
THT/CL-140-6T/9-15 IE3	955		22.50	13.07	11.00	12	77400	82	375
THT/CL-140-6T/9-20 IE3	950		29.00	16.78	15.00	16	91200	81	455
THT/CL-140-6T/9-25 IE3	975		36.10	20.77	18.50	20	103800	80	506
THT/CL-140-6T/9-30 IE3	975		42.30	24.35	22.00	22	111000	79	515
THT/CL-140-6T/9-40 IE3	985		56.00	32.50	30.00	28	128800	79	673
THT/CL-140-6T/9-50 IE3	980		67.20	39.00	37.00	32	135750	80	751

Technical characteristics

Model	Speed (r/min)	Maximum admissible current (A)			Installed power (kW)	Blade tilt angle (°)	Maximum flow rate (m³/h)	Sound pressure level¹ dB (A) Inlet	Approx. weight (Kg)
		230V	400V	690V					
THT/CL-140-6T/9-60 IE3	985		84.40	48.90	45.00	38	145610	82	986
THT/CL-140-6T/12-30 IE3	975		42.30	24.35	22.00	20	101570	81	531
THT/CL-140-6T/12-40 IE3	985		56.00	32.50	30.00	28	128800	80	686
THT/CL-140-6T/12-50 IE3	985		67.20	39.00	37.00	32	143360	81	769
THT/CL-140-6T/12-60 IE3	985		84.40	48.90	45.00	36	156705	82	979
THT/CL-140-6T/12-75 IE3	985		103.00	59.70	55.00	38	162890	83	1004
THT/CL-160-6T/6-20 IE3	950		29.00	16.78	15.00	12	111990	85	532
THT/CL-160-6T/6-25 IE3	975		36.10	20.77	18.50	14	121100	84	584
THT/CL-160-6T/6-30 IE3	975		42.30	24.35	22.00	16	129330	83	593
THT/CL-160-6T/6-40 IE3	985		56.00	32.50	30.00	22	153700	82	768
THT/CL-160-6T/6-50 IE3	980		67.20	39.00	37.00	26	170800	81	842
THT/CL-160-6T/6-60 IE3	985		84.40	48.90	45.00	30	185460	82	1064
THT/CL-160-6T/6-75 IE3	985		103.00	59.70	55.00	34	199030	83	1109
THT/CL-160-6T/9-25 IE3	975		36.10	20.77	18.50	10	104250	90	594
THT/CL-160-6T/9-30 IE3	975		42.30	24.35	22.00	14	126800	88	603
THT/CL-160-6T/9-40 IE3	985		56.00	32.50	30.00	18	145500	86	778
THT/CL-160-6T/9-50 IE3	980		67.20	39.00	37.00	20	154940	85	852
THT/CL-160-6T/9-60 IE3	985		84.40	48.90	45.00	24	176750	85	1067
THT/CL-160-6T/9-75 IE3	985		103.00	59.70	55.00	28	192290	84	1112
THT/CL-160-6T/12-60 IE3	985		84.40	48.90	45.00	20	151615	86	1071
THT/CL-160-6T/12-75 IE3	985		103.00	59.70	55.00	26	182250	85	1116

1 The noise level values are pressures in dB(A) measured at a distance of 3 metres in a free field.



Erp. (Energy Related Products)

Information on Directive 2009/125/EC can be downloaded from the SODECA website or the QuickFan selector programme.

Acoustic characteristics

Sound power spectrum Lw(A) in dB(A) per Hz frequency band
Values measured at inlet with maximum flow rate

	63	125	250	500	1000	2000	4000	8000		63	125	250	500	1000	2000	4000	8000
40-2-1.5	47	63	75	83	88	86	82	75	56-4-12 (2V)	39	52	70	78	80	79	74	67
40-4-1.5 (2V)	32	48	60	68	73	71	67	60	56-4-1	51	63	72	78	78	78	72	64
40-2-2	47	63	75	83	88	86	82	75	56-4-1.5	51	63	72	78	78	78	72	64
40-4-2 (2V)	32	48	60	68	73	71	67	60	56-8-1.5 (2V)	35	47	56	62	62	62	56	48
40-4-0.75	37	53	63	70	71	68	67	68	56-4-2	52	64	73	79	79	79	73	65
40-6-0.75	28	44	54	61	62	59	58	59	56-6-0.75	45	55	65	69	70	68	61	53
40-12-0.75 (2V)	12	28	38	45	46	43	42	43	56-12-0.75 (2V)	29	39	49	53	54	52	45	37
45-2-2	47	60	74	86	87	86	82	74	63-2-12	64	81	91	97	98	97	95	97
45-4-2 (2V)	32	45	59	71	72	71	67	59	63-2-20	63	80	90	96	97	96	94	96
45-2-3	47	64	74	81	88	86	83	75	63-4-1	48	64	76	82	84	81	74	66
45-4-3 (2V)	32	49	59	66	73	71	68	60	63-4-1.5	47	63	75	81	83	80	73	65
45-2-4	52	69	78	84	88	88	83	75	63-8-1.5 (2V)	31	47	59	65	67	64	57	49
45-4-0.75	47	59	67	73	73	73	68	60	63-4-2	54	66	75	81	81	81	75	67
45-6-0.75	37	49	57	63	63	63	58	50	63-8-2 (2V)	39	51	60	66	66	66	60	52
45-12-0.75 (2V)	21	33	41	47	47	47	42	34	63-4-3	56	68	77	83	83	83	77	69
50-2-3	58	74	84	91	92	89	88	89	63-8-3 (2V)	41	53	62	68	68	68	62	54
50-2-4	58	74	84	91	92	89	88	89	63-4-4	57	69	78	84	84	84	78	70
50-4-4 (2V)	43	59	69	76	77	74	73	74	63-8-4 (2V)	42	54	63	69	69	69	63	55
50-2-6	58	74	84	91	92	89	88	89	63-6-0.75	48	58	68	72	73	71	64	56
50-4-6 (2V)	43	59	69	76	77	74	73	74	63-12-0.75 (2V)	32	42	52	56	57	55	48	40
50-4-0.75	49	61	69	75	75	75	70	62	63-6-1	49	59	69	73	74	72	65	57
50-6-0.75	41	53	61	67	67	67	62	54	63-12-1 (2V)	32	42	52	56	57	55	48	40
56-2-5.5	53	66	84	92	94	93	88	81	71-4-1.5	57	73	80	86	86	86	82	74
56-2-6	53	66	84	92	94	93	88	81	71-8-1.5 (2V)	41	57	64	70	70	70	66	58
56-4-6 (2V)	38	51	69	77	79	78	73	66	71-4-2	56	72	79	85	85	85	81	73
56-2-12	54	67	85	93	95	94	89	82	71-8-2 (2V)	41	57	64	70	70	70	66	58

Acoustic characteristics

Sound power spectrum Lw(A) in dB(A) per Hz frequency band
Values measured at inlet with maximum flow rate

	63	125	250	500	1000	2000	4000	8000		63	125	250	500	1000	2000	4000	8000
71-4-3	56	72	79	85	85	85	81	73	125-4/9-25	67	81	94	102	104	101	96	88
71-8-3 (2V)	41	57	64	70	70	70	66	58	125-4/9-27	66	80	93	101	103	100	95	87
71-4-4	63	75	79	85	85	86	83	75	125-8/9-27 (2V)	51	65	78	86	88	85	80	72
71-8-4 (2V)	48	60	64	70	70	71	68	60	125-4/9-30	66	80	93	101	103	100	95	87
71-6-0.75	46	53	73	76	76	71	63	55	125-4/9-37	65	79	92	100	102	99	94	86
71-12-0.75 (2V)	30	37	57	60	60	55	47	39	125-8/9-37 (2V)	50	64	77	85	87	84	79	71
71-6-1	46	64	73	76	76	71	64	55	125-4/9-40	65	79	92	100	102	99	94	86
71-12-1 (2V)	29	47	56	59	59	54	47	38	125-4/9-50	65	79	92	100	102	99	94	86
71-6-1.5	47	65	74	77	77	72	65	56	125-4/9-60	73	86	95	99	101	100	96	89
71-12-1.5 (2V)	32	50	59	62	62	57	50	41	125-4/9-75	74	87	96	100	102	101	97	90
80-4-3	55	71	84	91	91	88	82	74	125-4/9-100	76	89	98	102	104	103	99	92
80-8-3 (2V)	40	56	69	76	76	73	67	59	125-4/12-50	66	80	93	101	103	100	95	87
80-4-4	54	70	83	90	90	87	81	73	125-4/12-60	66	80	93	101	103	100	95	87
80-8-4 (2V)	39	55	68	75	75	72	66	58	125-4/12-75	74	87	96	100	102	101	97	90
80-4-5.5	53	69	82	89	89	86	80	72	125-4/12-100	76	89	98	102	104	103	99	92
80-8-5.5 (2V)	38	54	67	74	74	71	65	57	125-6/6-5.5	64	79	89	92	93	90	85	77
80-6-1.5	53	68	75	78	79	76	70	62	125-6/6-7.5	62	77	87	90	91	88	83	75
80-12-1.5 (2V)	38	53	60	63	64	61	55	47	125-12/6-7.5 (2V)	47	62	72	75	76	73	68	60
80-6-2	59	69	75	79	80	78	73	65	125-6/6-10	61	76	86	89	90	87	82	74
80-12-2 (2V)	43	53	59	63	64	62	57	49	125-12/6-10 (2V)	46	61	71	74	75	72	67	59
80-6-3	60	70	76	80	81	79	74	66	125-6/6-15	61	76	86	89	90	87	82	74
80-12-3 (2V)	45	55	61	65	66	64	59	51	125-12/6-15 (2V)	45	60	70	73	74	71	66	58
80-8-0.75	46	59	67	72	74	71	64	53	125-6/6-20	63	78	88	91	92	89	84	76
80-8-1	47	60	68	73	75	72	65	54	125-6/6-24	65	80	90	93	94	91	86	78
90-4-4	61	77	88	94	95	93	88	80	125-12/6-24 (2V)	50	65	75	78	79	76	71	63
90-8-4 (2V)	46	62	73	79	80	78	73	65	125-6/9-10	61	76	87	93	94	88	84	77
90-4-5.5	60	76	87	93	94	92	87	79	125-12/9-10 (2V)	46	61	72	78	79	73	69	62
90-8-5.5 (2V)	45	61	72	78	79	77	72	64	125-6/9-15	59	74	85	91	92	86	82	75
90-4-7.5	59	75	86	92	93	91	86	78	125-12/9-15 (2V)	43	58	69	75	76	70	66	59
90-8-7.5 (2V)	44	60	71	77	78	76	71	63	125-6/9-20	59	74	85	91	92	86	82	75
90-4-10	58	74	85	91	92	90	85	77	125-6/9-24	60	75	86	92	93	87	83	76
90-8-10 (2V)	43	59	70	76	77	75	70	62	125-12/9-24 (2V)	45	60	71	77	78	72	68	61
90-6-2	52	67	78	82	82	78	71	63	125-6/9-25	61	76	87	93	94	88	84	77
90-12-2 (2V)	36	51	62	66	66	62	55	47	125-6/9-30	64	79	90	96	97	91	87	80
90-6-3	52	67	78	82	82	78	71	63	125-6/12-10	63	78	89	95	96	90	86	79
90-12-3 (2V)	37	52	63	67	67	63	56	48	125-6/12-15	61	76	87	93	94	88	84	77
90-6-4	60	70	80	85	85	82	76	68	125-6/12-20	60	75	86	92	93	87	83	76
90-12-4 (2V)	45	55	65	70	70	67	61	53	125-6/12-25	61	76	87	93	94	88	84	77
90-8-1	42	63	70	75	78	74	67	56	125-6/12-30	62	77	88	94	95	89	85	78
90-8-2	51	66	73	78	81	77	70	59	125-6/12-40	63	78	89	95	96	90	86	79
90-8-3	53	67	74	79	82	78	71	60	140-6/6-7.5	63	79	91	97	98	96	94	96
100-4-7.5	67	83	90	97	98	96	92	84	140-6/6-15	58	74	86	92	93	91	89	91
100-8-7.5 (2V)	52	68	75	82	83	81	77	69	140-6/6-20	57	73	85	91	92	90	88	90
100-4-10	65	81	88	95	96	94	90	82	140-6/6-25	56	72	84	92	94	89	87	89
100-8-10 (2V)	50	66	73	80	81	79	75	67	140-6/6-30	57	73	85	91	92	90	88	90
100-4-15	71	83	87	93	94	94	91	83	140-6/9-15	64	77	89	97	99	95	91	83
100-8-15 (2V)	56	68	72	78	79	79	76	68	140-6/9-20	63	76	88	96	98	94	90	82
100-4-20	72	84	88	94	95	95	92	84	140-6/9-25	62	75	87	95	97	93	89	81
100-8-20 (2V)	57	69	73	79	80	80	77	69	140-6/9-30	61	74	86	94	96	92	88	80
100-4/9-15	65	81	88	95	96	94	90	82	140-6/9-40	61	74	86	94	96	92	88	80
100-4/9-20	72	84	88	94	95	95	92	84	140-6/9-50	52	65	76	85	91	94	98	92
100-4/9-25	72	84	88	94	95	95	92	84	140-6/9-60	54	67	78	87	93	96	100	94
100-4/9-30	74	86	90	96	97	97	94	86	140-6/12-30	63	76	88	96	98	94	90	82
100-6-3	57	72	82	85	86	83	75	67	140-6/12-40	62	75	87	95	97	93	89	81
100-12-3 (2V)	42	57	67	70	71	68	60	52	140-6/12-50	53	66	77	86	92	95	99	93
100-6-4	56	71	81	84	85	82	74	66	140-6/12-60	54	67	78	87	93	96	100	94
100-12-4 (2V)	41	56	66	69	70	67	59	51	140-6/12-75	55	68	79	88	94	97	101	95
100-6-5.5	57	72	82	85	86	83	75	67	160-6/6-20	67	83	92	99	100	98	97	97
100-6/9-5.5	57	72	82	85	86	83	75	67	160-6/6-25	66	82	91	98	99	97	96	96
100-6/9-7.5	58	73	83	86	87	84	76	68	160-6/6-30	66	82	91	98	99	96	96	96
100-6/9-10	61	76	86	89	90	87	79	71	160-6/6-40	64	80	89	96	97	95	94	94
125-4/6-20	69	85	96	103	104	102	95	87	160-6/6-50	64	80	89	96	97	94	94	94
125-8/6-20 (2V)	54	70	81	88	89	87	80	72	160-6/6-60	64	80	89	96	97	95	94	94
125-4/6-25	68	84	95	102	103	101	94	86	160-6/6-75	56	69	78	86	92	97	100	100
125-4/6-27	67	83	94	101	102	100	93	85	160-6/9-25	75	88	97	105	107	105	100	91
125-8/6-27 (2V)	52	68	79	86	87	85	78	70	160-6/9-30	73	86	95	103	105	103	98	89
125-4/6-30	67	83	94	101	102	100	93	85	160-6/9-40	71	84	93	101	103	101	96	87
125-4/6-37	67	83	94	101	102	100	93	85	160-6/9-50	70	83	92	100	102	100	95	86
125-8/6-37 (2V)	52	68	79	86	87	85	78	70	160-6/9-60	70	83	92	100	102	100	95	86
125-4/6-40	67	83	94	101	102	100	93	85	160-6/9-75	59	72	80	87	88	100	103	96
125-4/6-50	67	83	94	101	102	100	93	85	160-6/12-60	71	84	93	101	103	101	96	87
125-4/6-60	67	83	94	101	102	100	93	85	160-6/12-75	60	73	81	88	89	101	104	97
125-4/6-75	70	86	97	104	105	103	96	88									

Dimensions mm

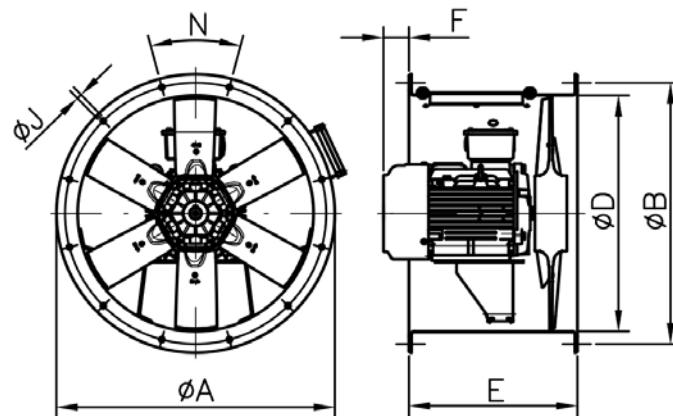

Motor size	ØA	ØB	ØD	E	F*	ØJ	N	
THT/CL-40	80	490	450	410	400	-	12	8x45°
THT/CL-40	90S	490	450	410	400	-	12	8x45°
THT/CL-40	90L	490	450	410	400	29	12	8x45°
THT/CL-45	80	540	500	460	400	-	12	8x45°
THT/CL-45	90S	540	500	460	400	-	12	8x45°
THT/CL-45	90L	540	500	460	400	29	12	8x45°
THT/CL-45	100	540	500	460	400	35	12	8x45°
THT/CL-50	80	600	560	514	400	-	12	12x30°
THT/CL-50	90S	600	560	514	400	-	12	12x30°
THT/CL-50	90L	600	560	514	400	29	12	12x30°
THT/CL-50	100	600	560	514	400	35	12	12x30°
THT/CL-50	112	600	560	514	400	56.5	12	12x30°
THT/CL-56	80	660	620	560	400	-	12	12x30°
THT/CL-56	90S	660	620	560	400	-	12	12x30°
THT/CL-56	90L	660	620	560	400	29	12	12x30°
THT/CL-56	100	660	620	560	500	-	12	12x30°
THT/CL-56	112	660	620	560	500	60.5	12	12x30°
THT/CL-56	132S	660	620	560	500	15	12	12x30°
THT/CL-56	132M	660	620	560	500	53	12	12x30°
THT/CL-63	80	730	690	640	400	-	12	12x30°
THT/CL-63	90S	730	690	640	400	-	12	12x30°
THT/CL-63	90L	730	690	640	400	29	12	12x30°
THT/CL-63	100	730	690	640	500	-	12	12x30°
THT/CL-63	112	730	690	640	500	-	12	12x30°
THT/CL-63	132S	730	690	640	500	43	12	12x30°
THT/CL-63	132M	730	690	640	500	81	12	12x30°
THT/CL-63	160M	730	690	640	650	-	12	12x30°
THT/CL-63	160L	730	690	640	650	29	12	12x30°
THT/CL-71	80	810	770	710	430	-	12	16x22°30'
THT/CL-71	90S	810	770	710	430	-	12	16x22°30'
THT/CL-71	90L	810	770	710	430	19	12	16x22°30'
THT/CL-71	100	810	770	710	430	24	12	16x22°30'
THT/CL-71	112	810	770	710	500	-	12	16x22°30'
THT/CL-80	90L	900	860	800	430	27	12	16x22°30'
THT/CL-80	100	900	860	800	500	-	12	16x22°30'
THT/CL-80	112	900	860	800	500	-	12	16x22°30'
THT/CL-80	132S	900	860	800	600	-	12	16x22°30'

Motor size	ØA	ØB	ØD	E	F*	ØJ	N	
THT/CL-90	100	1015	970	900	600	-	15	16x22°30'
THT/CL-90	112	1015	970	900	600	-	15	16x22°30'
THT/CL-90	132S	1015	970	900	600	-	15	16x22°30'
THT/CL-90	132M	1015	970	900	600	-	15	16x22°30'
THT/CL-100	112	1115	1070	1000	600	-	15	16x22°30'
THT/CL-100	132S	1115	1070	1000	600	-	15	16x22°30'
THT/CL-100	132M	1115	1070	1000	600	-	15	16x22°30'
THT/CL-100	160M	1115	1070	1000	700	-	15	16x22°30'
THT/CL-100	160L	1115	1070	1000	700	2	15	16x22°30'
THT/CL-100	180M	1115	1070	1000	700	11	15	16x22°30'
THT/CL-100	180L	1115	1070	1000	700	49	15	16x22°30'
THT/CL-125	132M	1365	1320	1250	700	-	15	20x18°
THT/CL-125	160M	1365	1320	1250	700	-	15	20x18°
THT/CL-125	160L	1365	1320	1250	700	-	15	20x18°
THT/CL-125	180M	1365	1320	1250	900	-	15	20x18°
THT/CL-125	180L	1365	1320	1250	900	-	15	20x18°
THT/CL-125	200	1365	1320	1250	900	-	15	20x18°
THT/CL-125	225	1365	1320	1250	1000	-	15	20x18°
THT/CL-125	250	1365	1320	1250	1000	25.5	15	20x18°
THT/CL-125	280	1365	1320	1250	1200	-	15	20x18°
THT/CL-140	132S	1515	1470	1400	650	-	15	20x18°
THT/CL-140	132M	1515	1470	1400	650	-	15	20x18°
THT/CL-140	160L	1515	1470	1400	700	5	15	20x18°
THT/CL-140	180L	1515	1470	1400	900	-	15	20x18°
THT/CL-140	200	1515	1470	1400	900	-	15	20x18°
THT/CL-140	225	1515	1470	1400	1000	-	15	20x18°
THT/CL-140	250	1515	1470	1400	1000	5.5	15	20x18°
THT/CL-140	280	1515	1470	1400	1200	5.5	15	20x18°
THT/CL-160	132S	1735	1680	1600	650	-	19	24x15°
THT/CL-160	132M	1735	1680	1600	650	-	19	24x15°
THT/CL-160	160L	1735	1680	1600	700	5	19	24x15°
THT/CL-160	180L	1735	1680	1600	900	-	19	24x15°
THT/CL-160	200	1735	1680	1600	900	-	19	24x15°
THT/CL-160	225	1735	1680	1600	1000	-	19	24x15°
THT/CL-160	250	1735	1680	1600	1000	30.5	19	24x15°
THT/CL-160	280	1735	1680	1600	1200	-	19	24x15°

* Dimension F only applies to F400 models.

Motor build sizes depending on power (1 speed)

	HP											
	0.75	1	1.5	2	3	4	5.5	7.5	10	12	15	20
2T (3000 r/min)	80	80	80	90S	90L	100LB	112M	132S	132S	132MA	160M	160M
4T (1500 r/min)	80	90S	90S	90L	100LA	100LB	112M	132S	132M	-	160ML	160L
6T (1000 r/min)	90S	90S	90L	100L	112M	132S	132MA	132MB	160M	-	160L	180ML
8T (750 r/min)	90L	100LA	100L	112M	132S	132M	160MA	160M	160L	-	180L	200MLA

	HP							
	22	25	30	40	50	60	75	100
2T (3000 r/min)	160L	180M	180L	200L	225S/M	225S/M	250S/M	280S/M
4T (1500 r/min)	-	180M	180L	200L	225S/M	225S/M	250S/M	280S/M
6T (1000 r/min)	-	200MLA	200MLB	225SMB	250S/M	280S/M	280S/M	-
8T (750 r/min)	-	225SMA	225SMB	250SMA	280S/M	280S/M	-	-

Motor build sizes depending on power (2 speeds)

	HP											
	0.75	1	1.5	2	3	4	5.5	6	7.5	8	9	10
2/4 (3000/1500 r/min)	-	-	90S	90S	90L	100L	-	112M	-	-	132M	-
4/8 (1500/750 r/min)	-	-	90S	100L	100LA	100LC	132S	-	132S	132S	132ML	132M
6/12 (1000/500 r/min)	90L	100L	100LB	112M	112M	132MC	160M	160M	160LB	160LB	-	160LB

	HP									
	12	15	18	20	22	24	27	37	38	40
2/4 (3000/1500 r/min)	160MA	-	160M	-	160L	-	-	-	-	-
4/8 (1500/750 r/min)	-	160M	-	160L	180M	180M	180L	200MLA	200L	225S/M
6/12 (1000/500 r/min)	-	200MLC	160L	200M	-	250SMB	225S/M	-	225S/M	-

Accessories



INT



IAT



CABLE BOX



C2V



VSD3/A-RFT
- VSD1/A-RFM



CENTRAL CO



AET



P-400



RT



R/THT



BTUB



BAC



PS



ACE ACE/400



S



SC



BOXPARK

Configuration with BOXPARK



Control panels for car park ventilation systems with triple purpose: daily ventilation, CO concentration control and smoke extraction in case of fire

Control panels in metal enclosure with all the necessary elements for the management and control of fans in car park ventilation systems, whether they are based on duct networks or impulse fans, for the control of CO concentration levels and smoke extraction in case of fire. Customised panels for all power ratings and number of fans according to project requirements.

More information see BOXPARK series.

Installation examples with BOXPARK

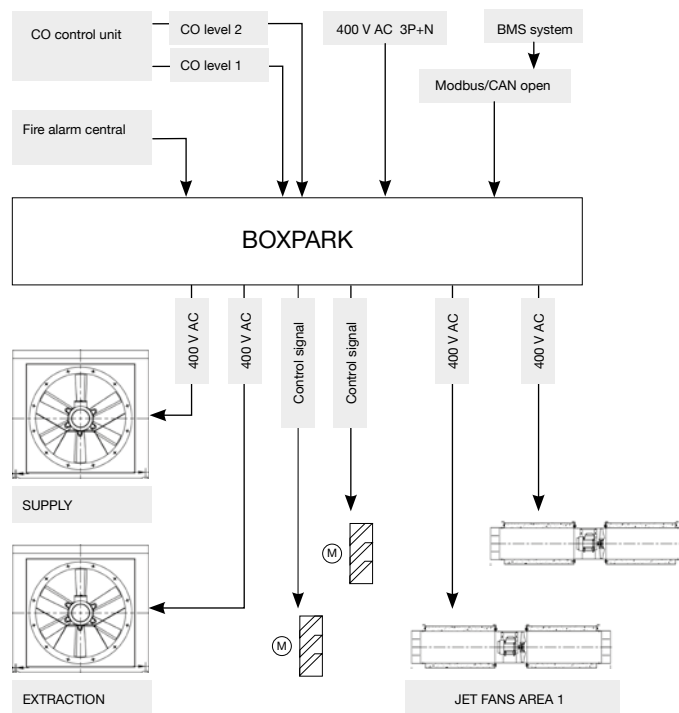

EXAMPLE OF SELECTION

Characteristic curves

Q= Flow rate in m³/h, m³/s and cfm

Pe= Static pressure in mm H₂O, Pa and inwg

Impeller diameter in cm: 71

Number of motor poles: 6

Number of blades: 6

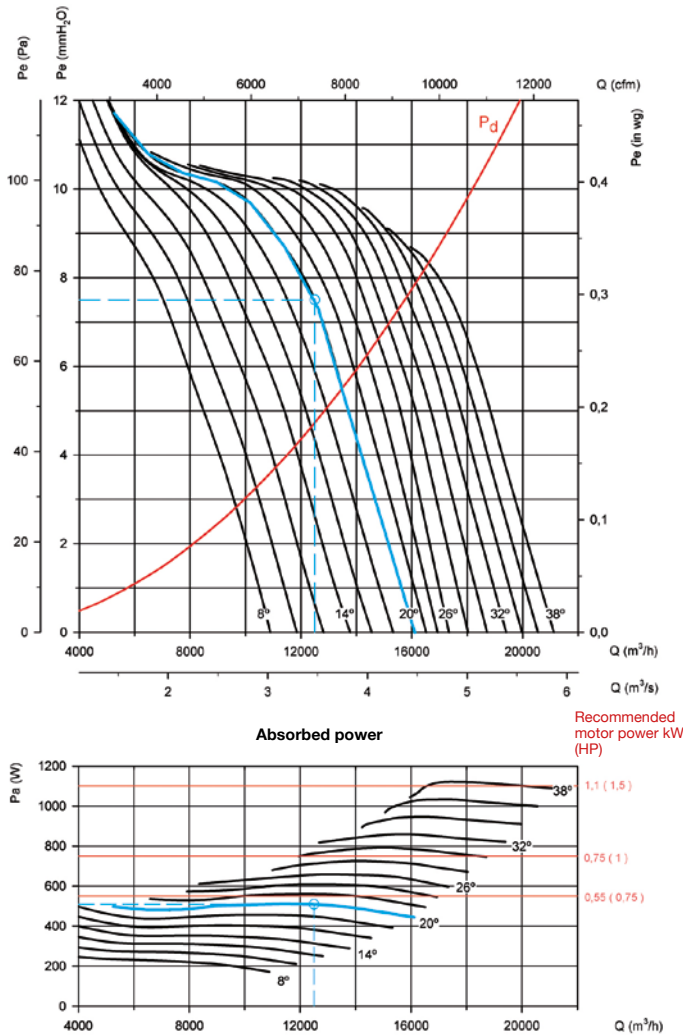

Initial data

Working point:

- Flow rate: 12,500 m³/h
- Loss of load: 7.5 mmH₂O

Steps for the selection of equipment

On the pressure graph:

- Mark the working point, defined by the airflow (12,500 m³/h) and the loss of load (7.5 mmH₂O).
- Select the curve of the equipment which is closest above the working point. In our case, a curve with a blade angle of 20° is obtained.

On the power graph:

- Mark the working point, defined by the airflow (12,500 m³/h) and the selected blade angle (20°).
- Read the absorbed power on the power axis on the left. Pa= 510 W at the working point.
- Look for the straight red line which is closest to the working point above. On the right-hand side of the graph, the value of the installed motor power is obtained. In our case, this is 0.55 kW or 0.75 HP.

EXAMPLE OF ORDER CODE

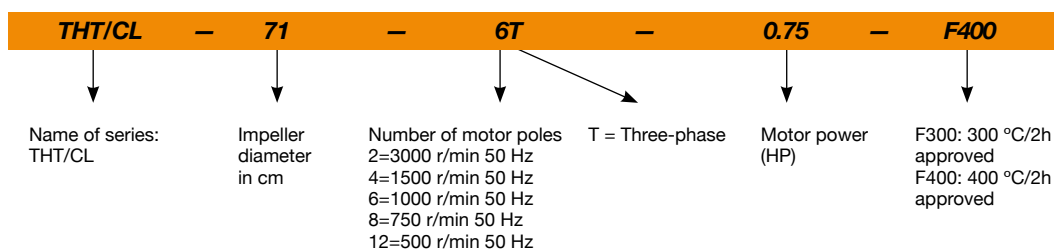

Characteristic curves

Q= Flow rate in m³/h, m³/s and cfm

Pe= Static pressure in mm H₂O, Pa and inwg

Impeller diameter in cm: 40

Number of motor poles: 2

Number of blades: 6

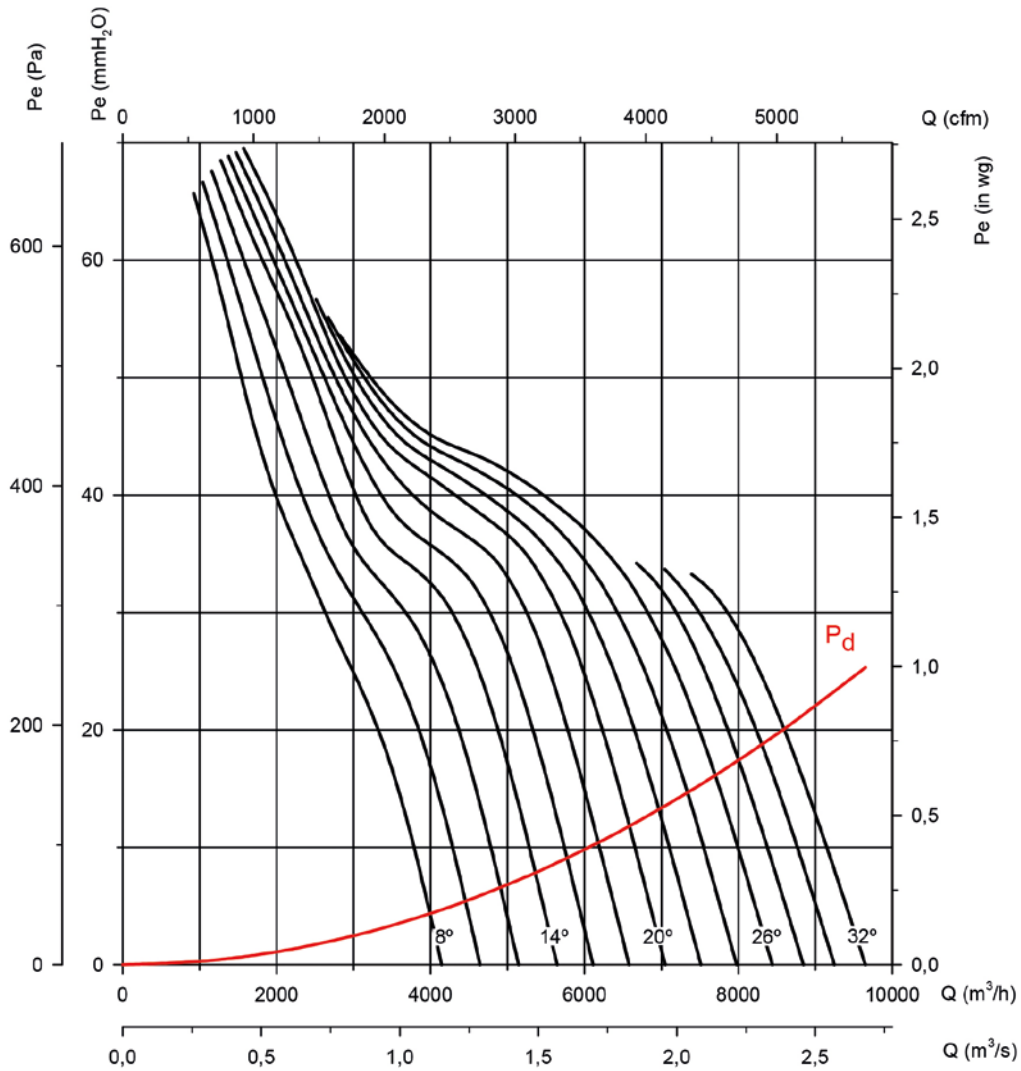

Absorbed power

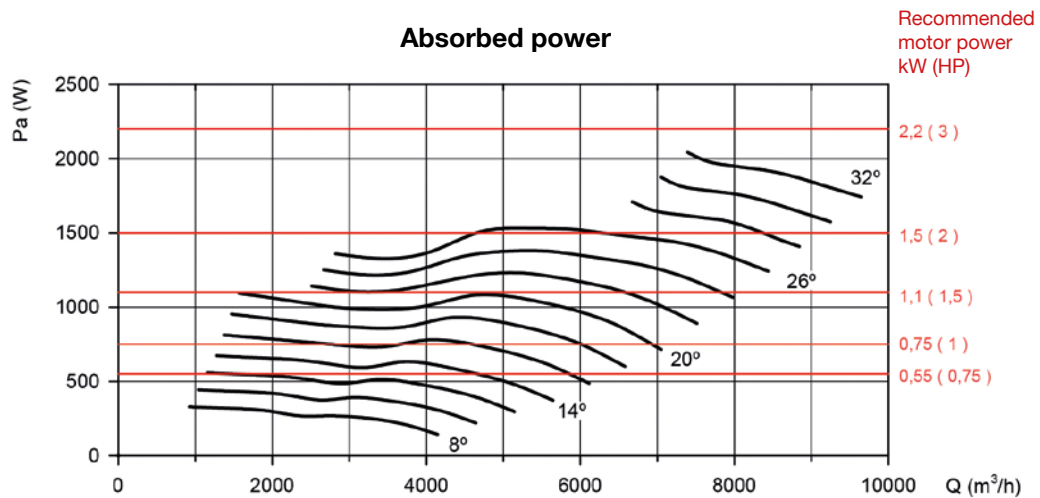

Characteristic curves

Q= Flow rate in m³/h, m³/s and cfm

Pe= Static pressure in mm H₂O, Pa and inwg

Impeller diameter in cm: 40

Number of motor poles: 4

Number of blades: 6

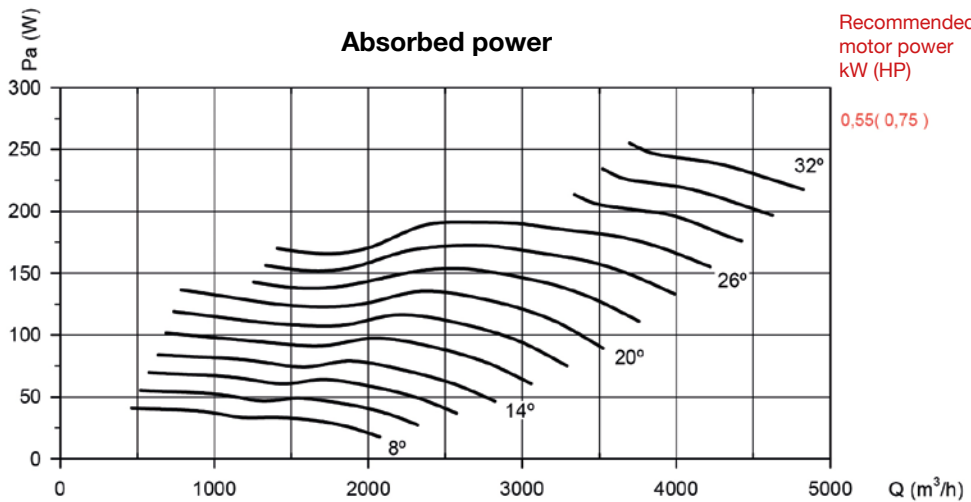
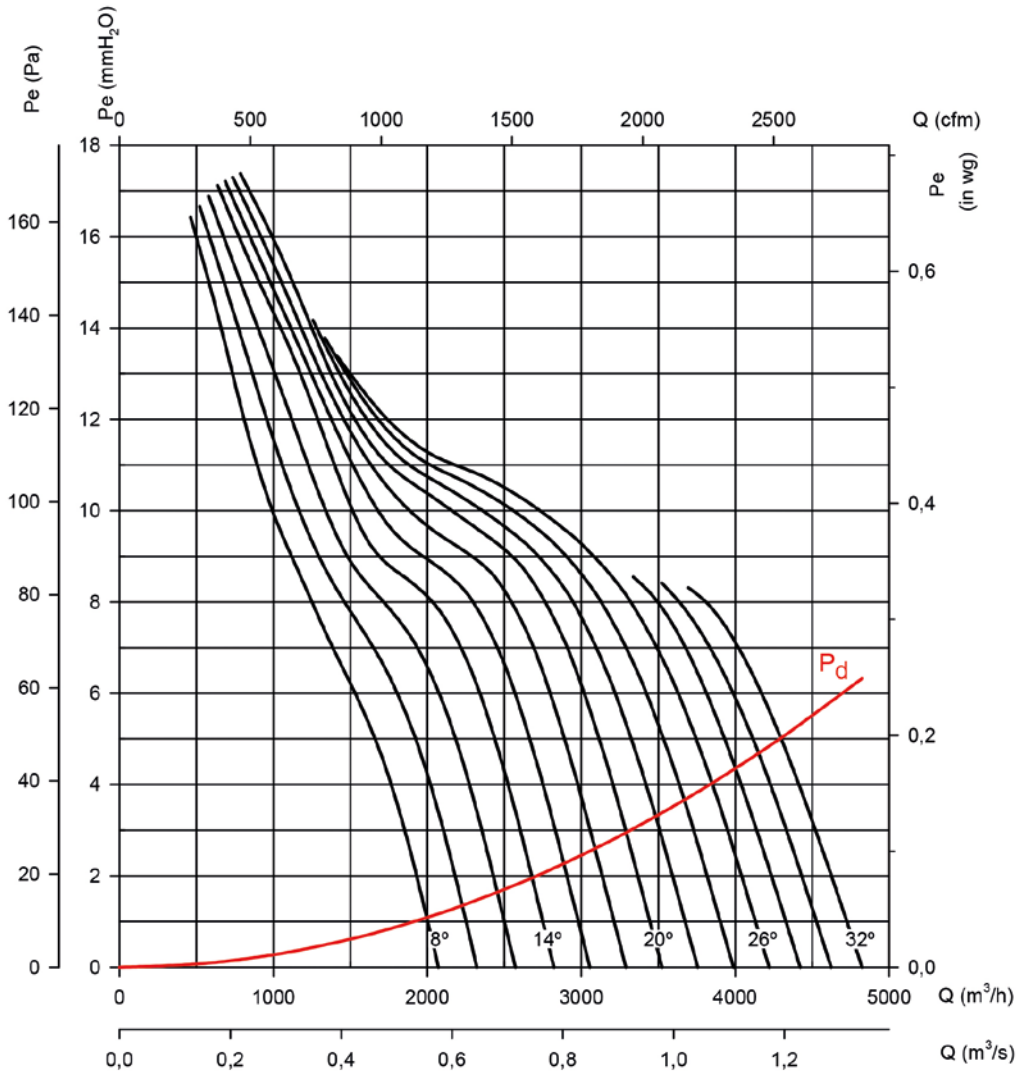

Characteristic curves

Q= Flow rate in m³/h, m³/s and cfm

Pe= Static pressure in mm H₂O, Pa and inwg

Impeller diameter in cm: 40

Number of motor poles: 6

Number of blades: 6

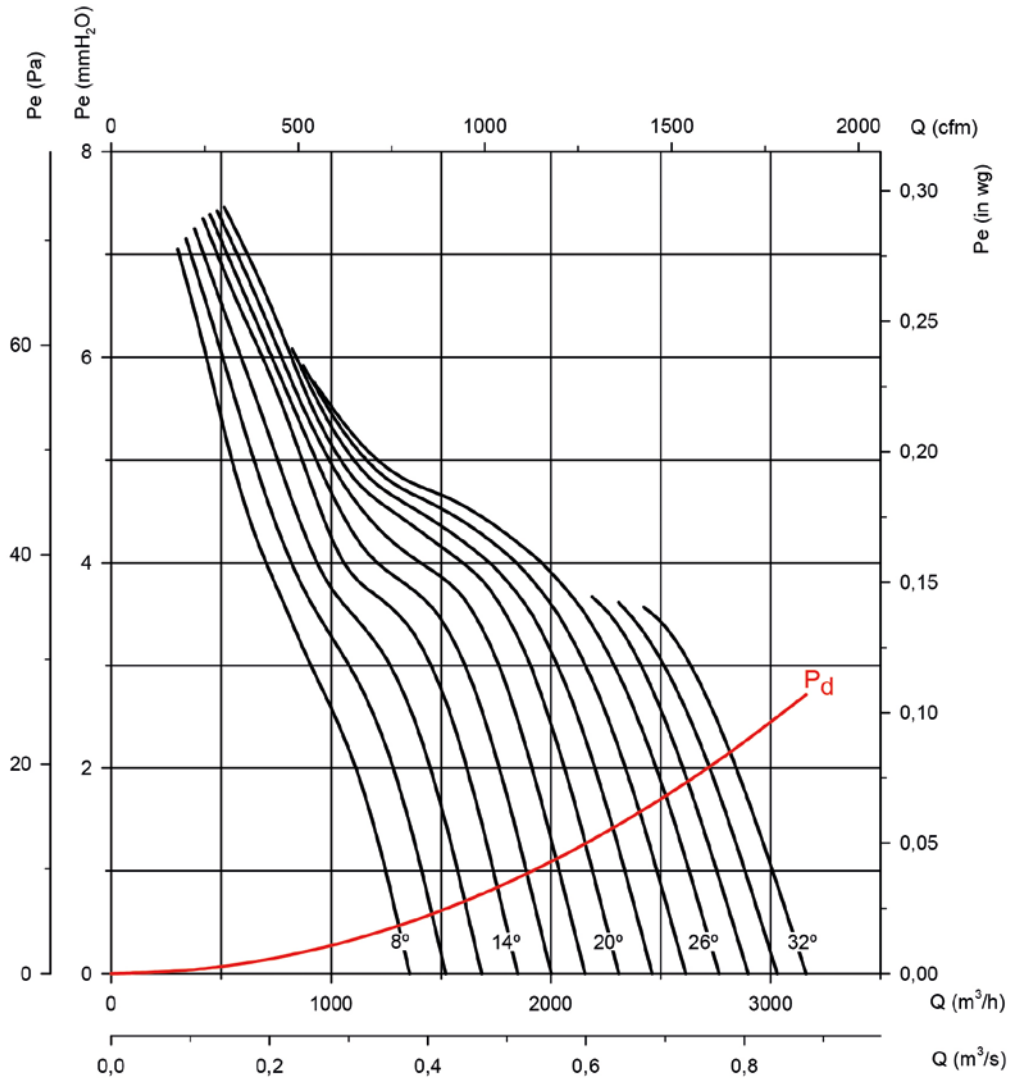

Absorbed power

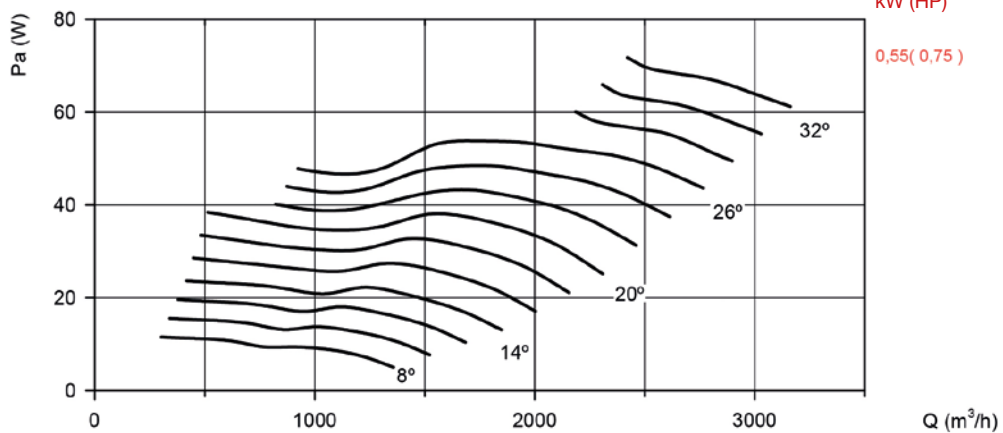

Characteristic curves

Q= Flow rate in m³/h, m³/s and cfm

Pe= Static pressure in mm H₂O, Pa and inwg

Impeller diameter in cm: 45

Number of motor poles: 2

Number of blades: 6

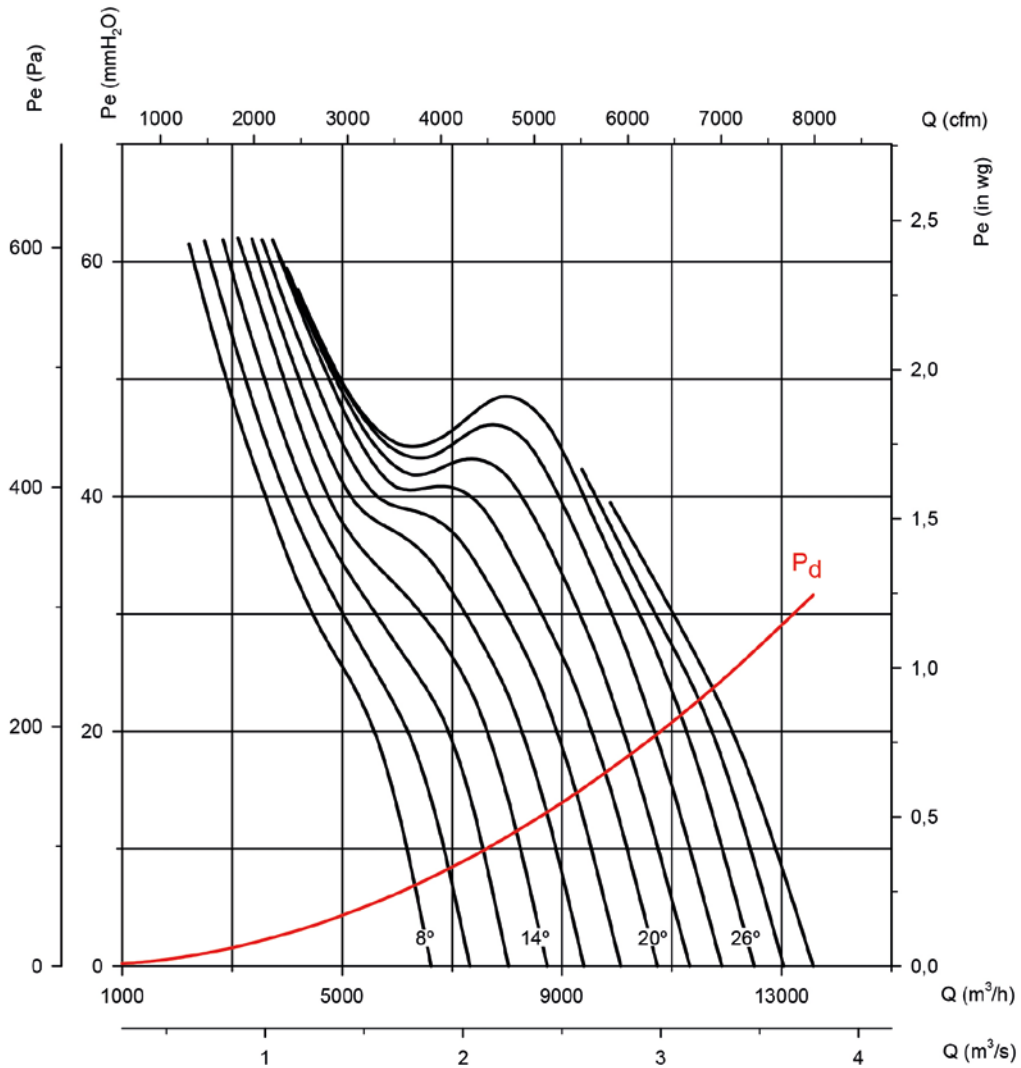

Absorbed power

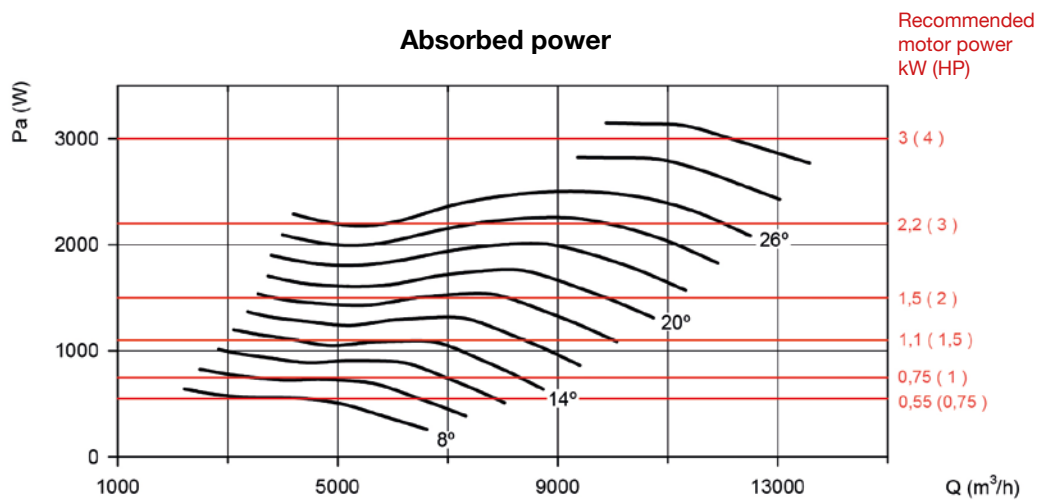

Characteristic curves

Q= Flow rate in m³/h, m³/s and cfm

Pe= Static pressure in mm H₂O, Pa and inwg

Impeller diameter in cm: 45

Number of motor poles: 4

Number of blades: 6

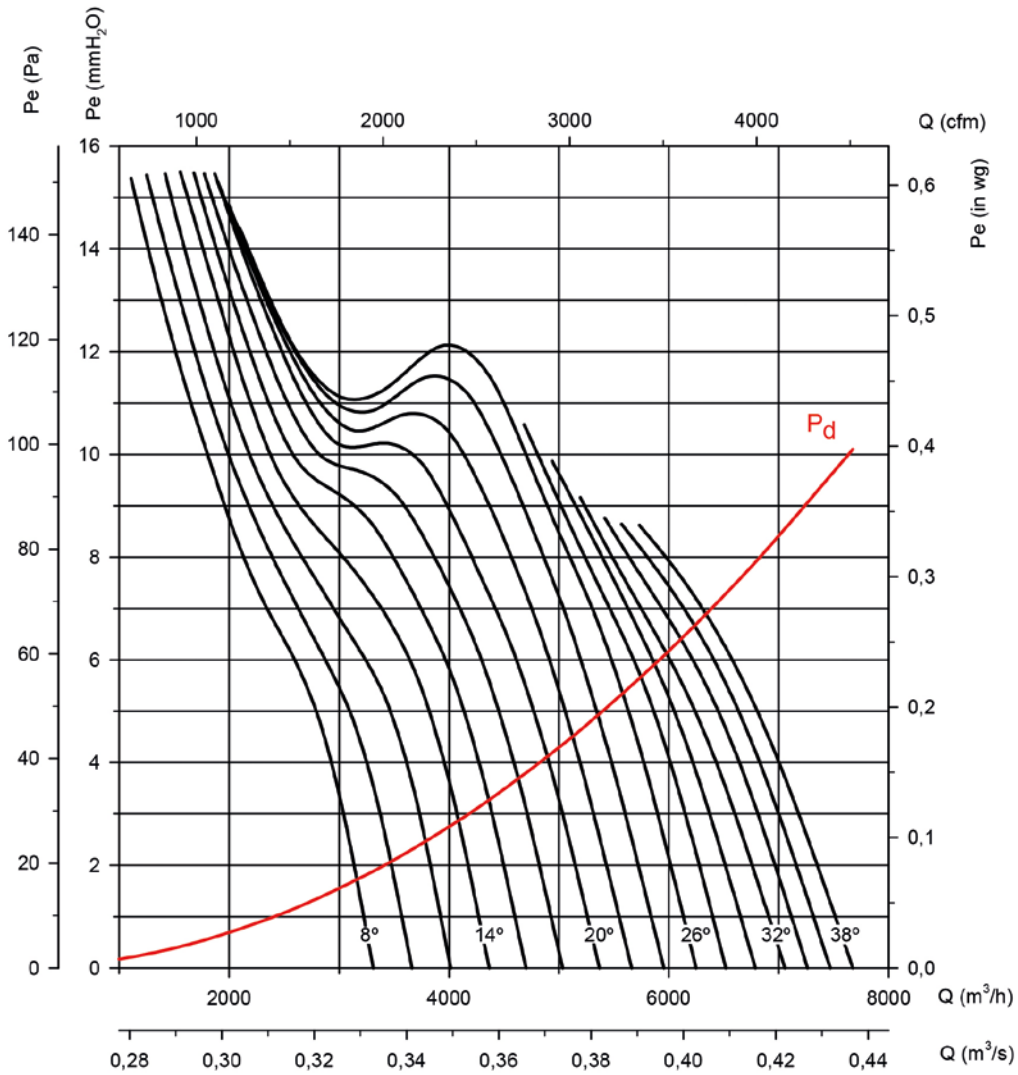

Absorbed power

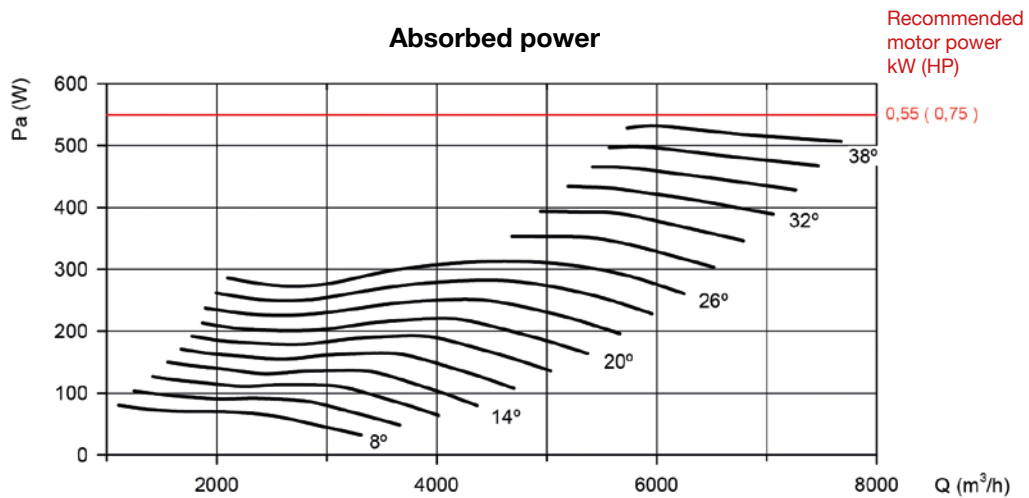

Characteristic curves

Q= Flow rate in m³/h, m³/s and cfm Pe= Static pressure in mm H₂O, Pa and inwg

Impeller diameter in cm: 45

Number of motor poles: 6

Number of blades: 6

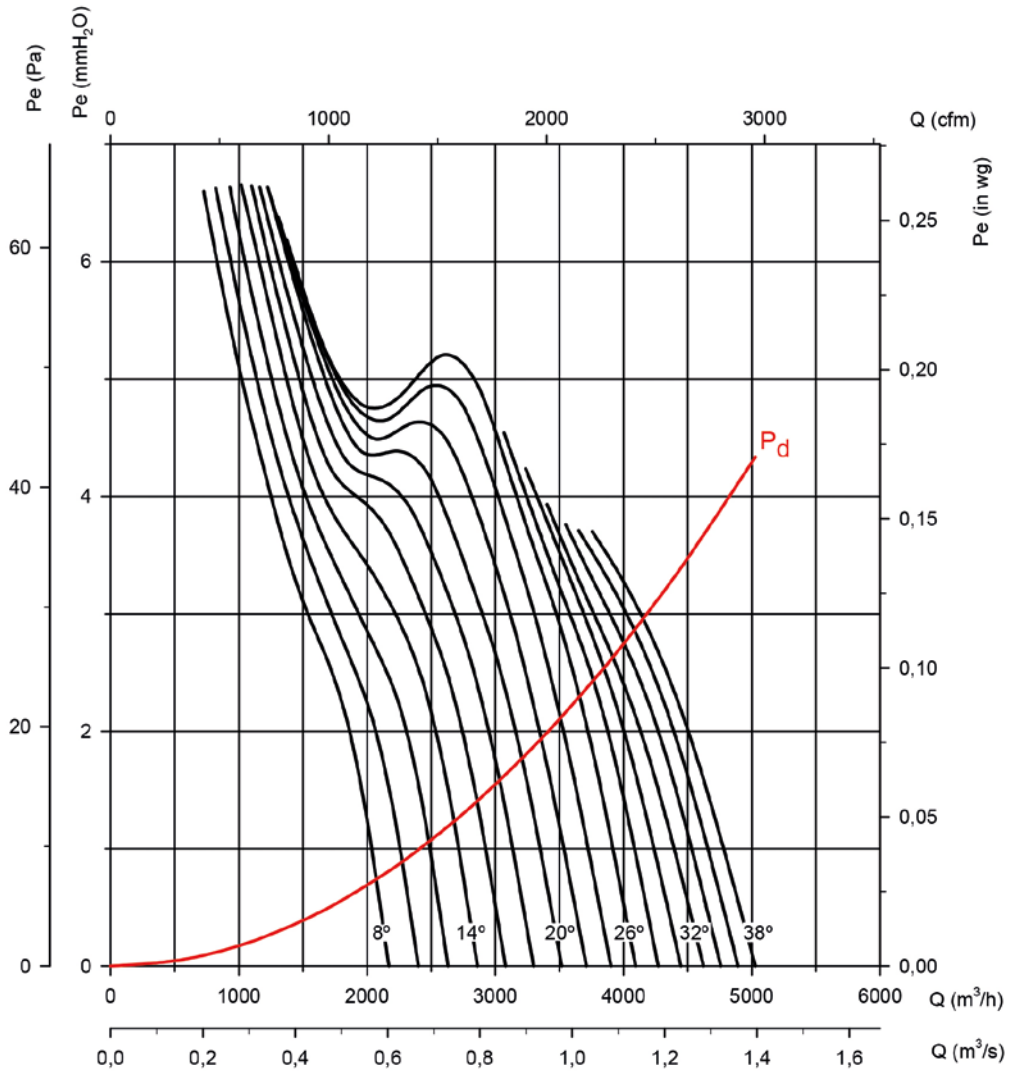

Absorbed power

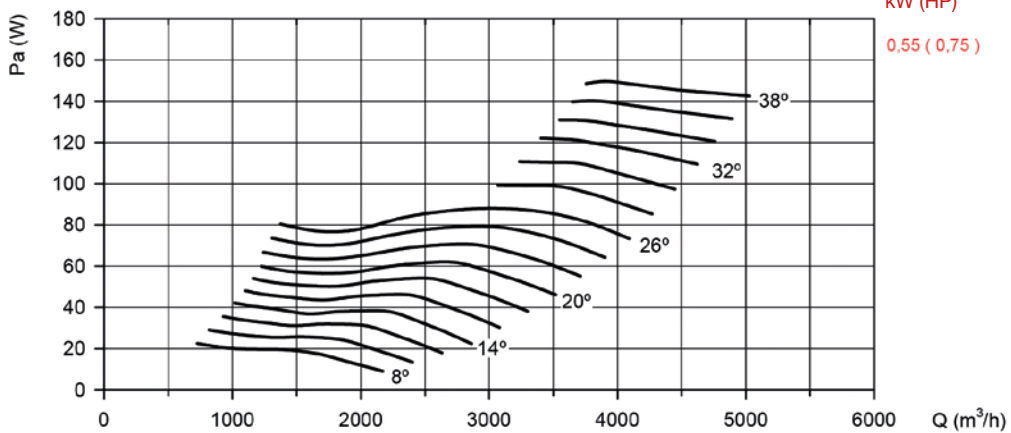

Recommended
motor power
kW (HP)
0,55 (0,75)

Characteristic curves

Q= Flow rate in m³/h, m³/s and cfm

Pe= Static pressure in mm H₂O, Pa and inwg

Impeller diameter in cm: 50

Number of motor poles: 2

Number of blades: 6

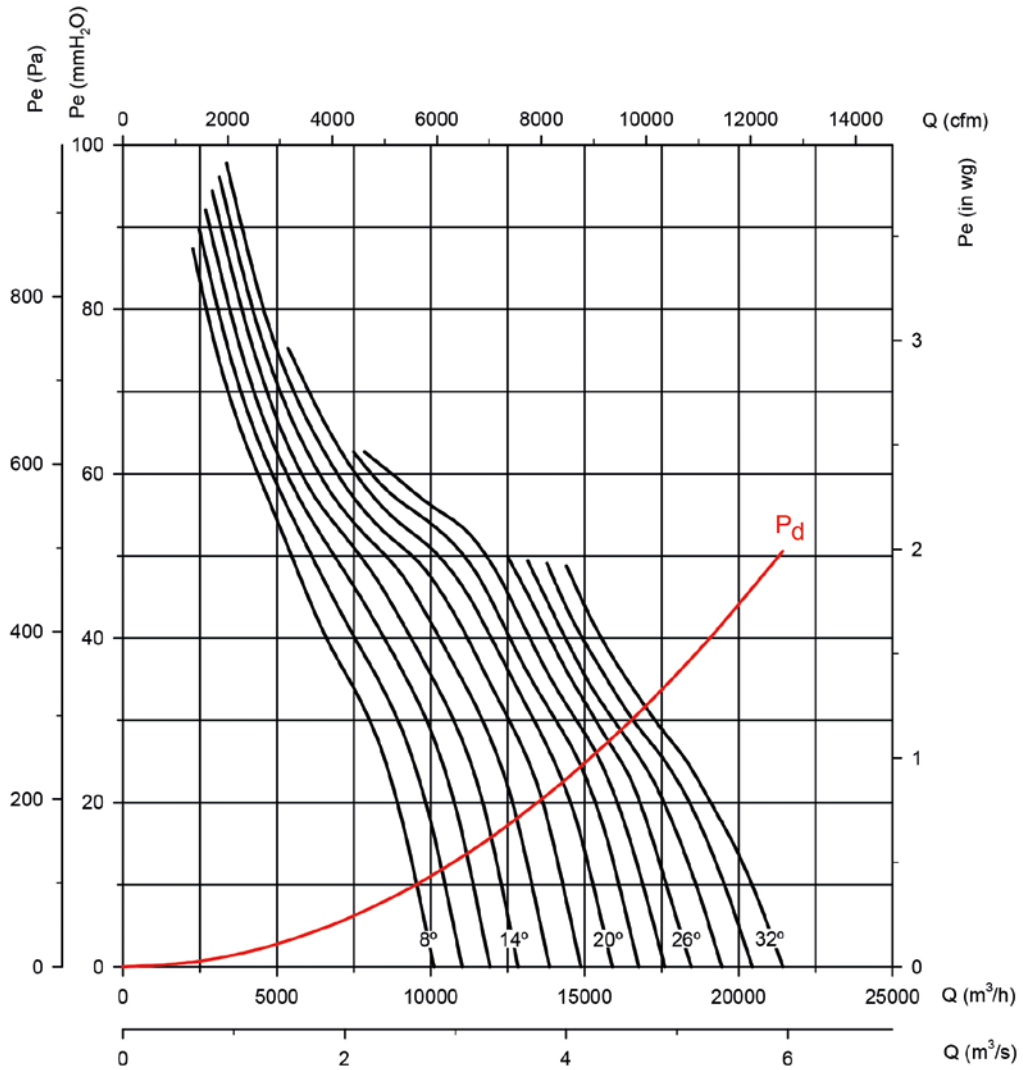

Absorbed power

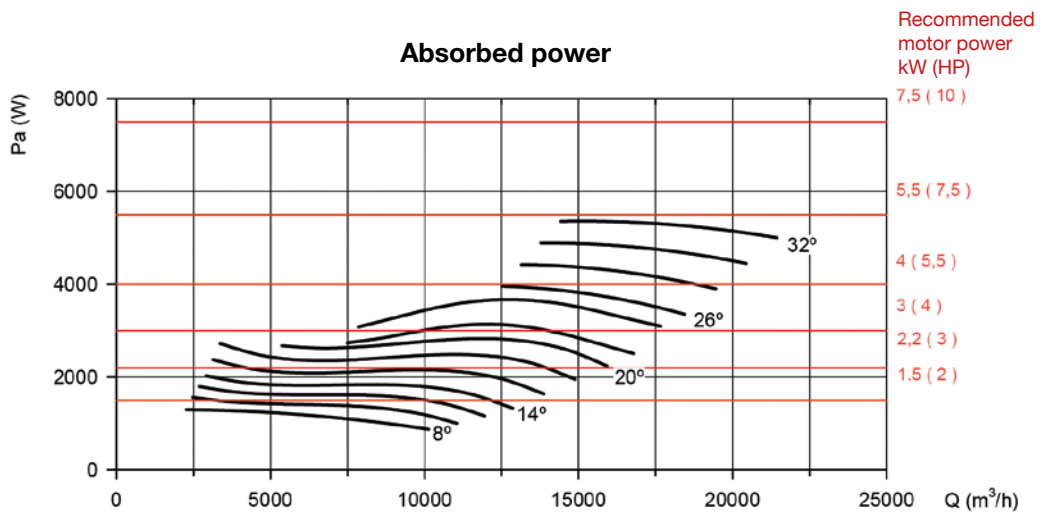

Characteristic curves

Q= Flow rate in m³/h, m³/s and cfm Pe= Static pressure in mm H₂O, Pa and inwg

Impeller diameter in cm: 50

Number of motor poles: 4

Number of blades: 6

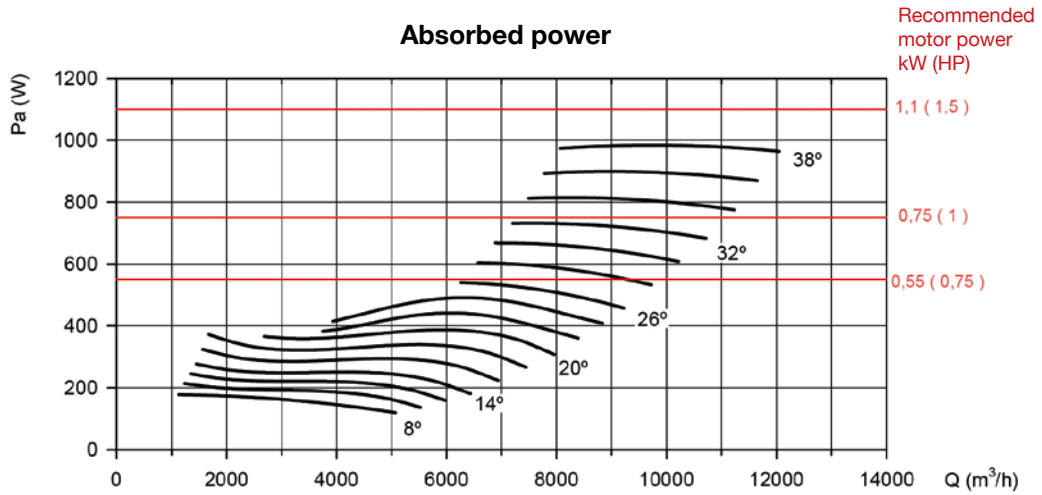
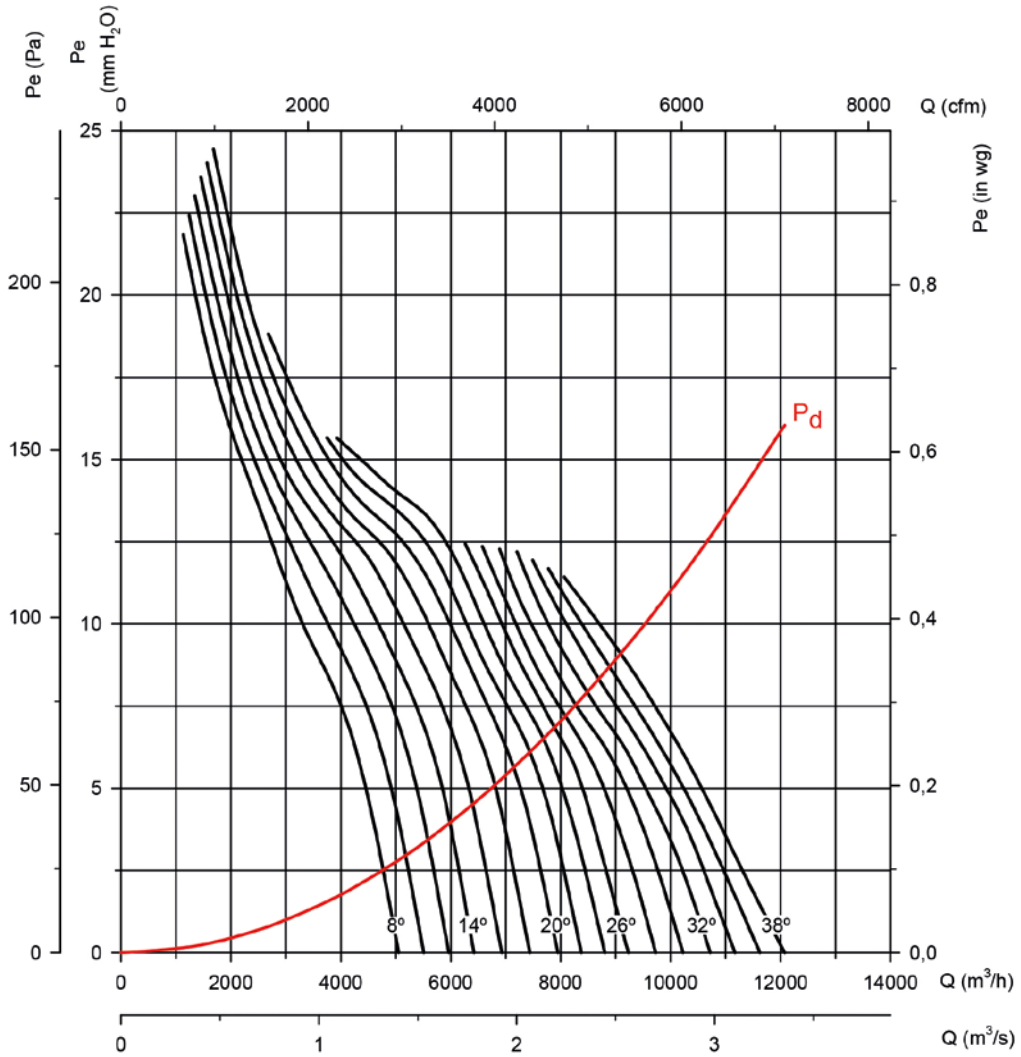

Characteristic curves

Q= Flow rate in m³/h, m³/s and cfm

Pe= Static pressure in mm H₂O, Pa and inwg

Impeller diameter in cm: 50

Number of motor poles: 6

Number of blades: 6

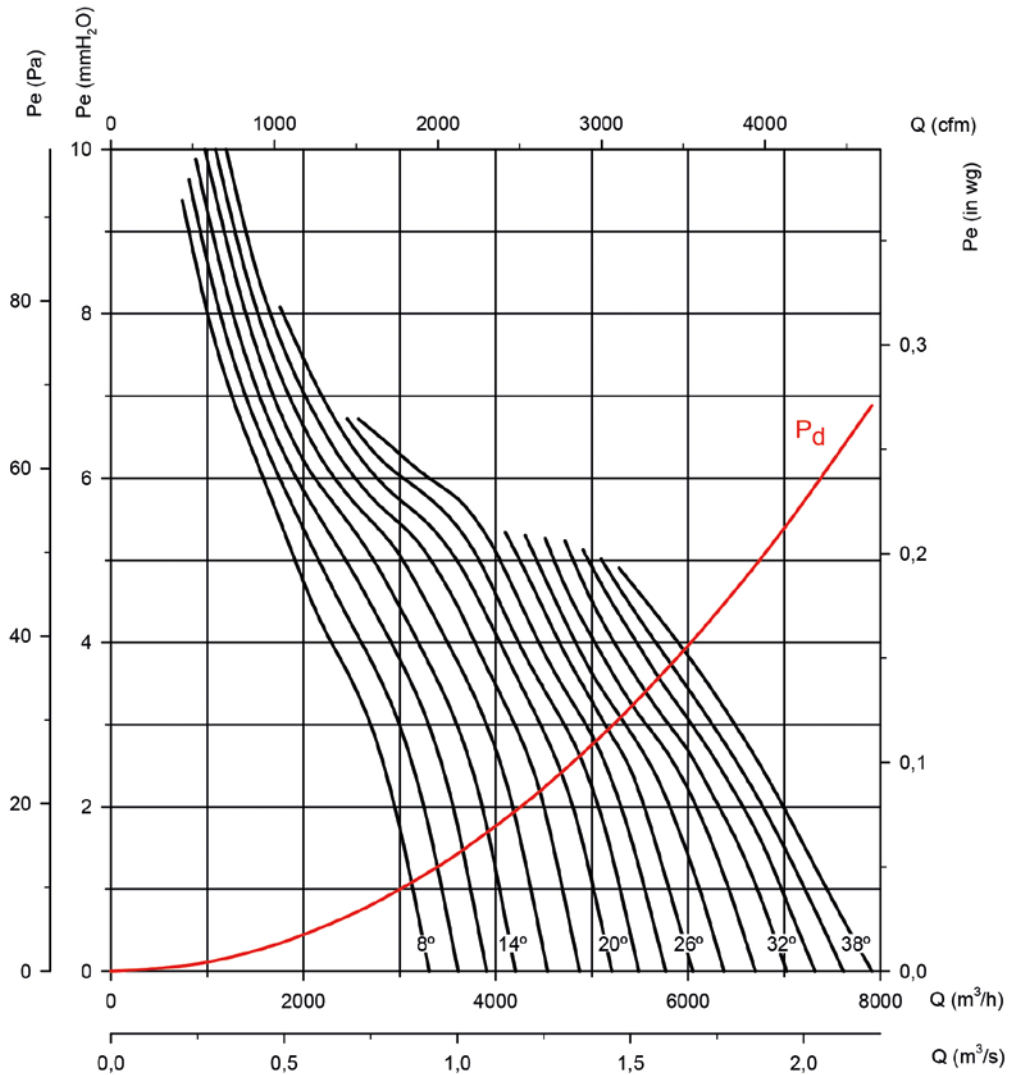

Absorbed power

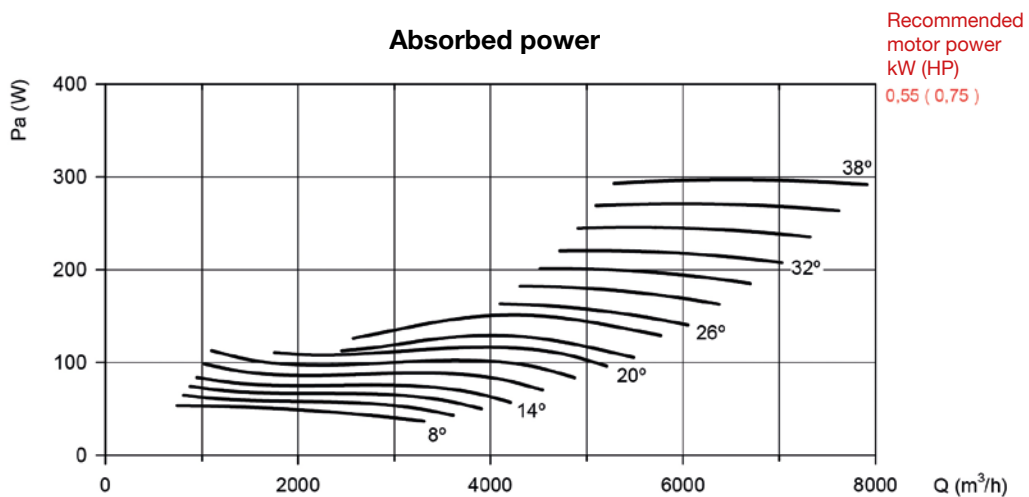

Characteristic curves

Q= Flow rate in m³/h, m³/s and cfm Pe= Static pressure in mm H₂O, Pa and inwg

Impeller diameter in cm: 56

Number of motor poles: 2

Number of blades: 6

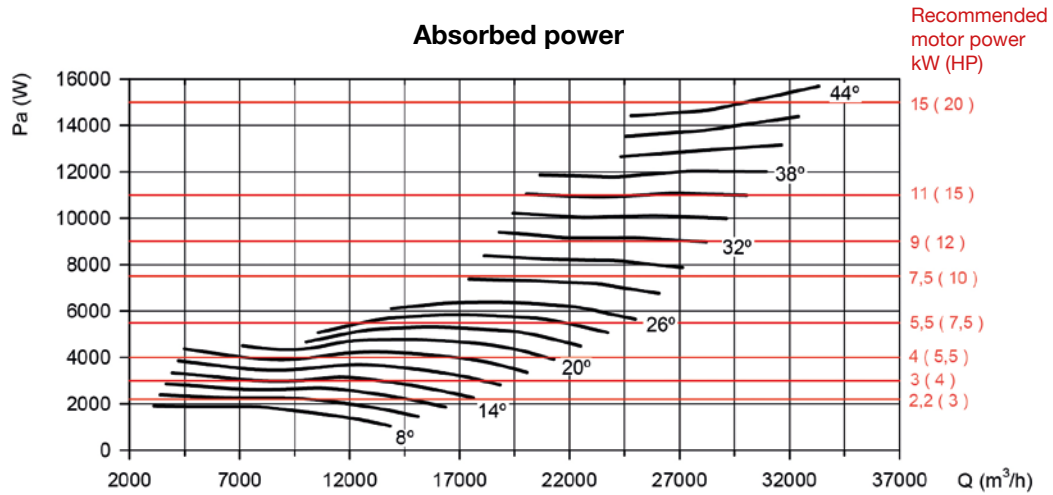
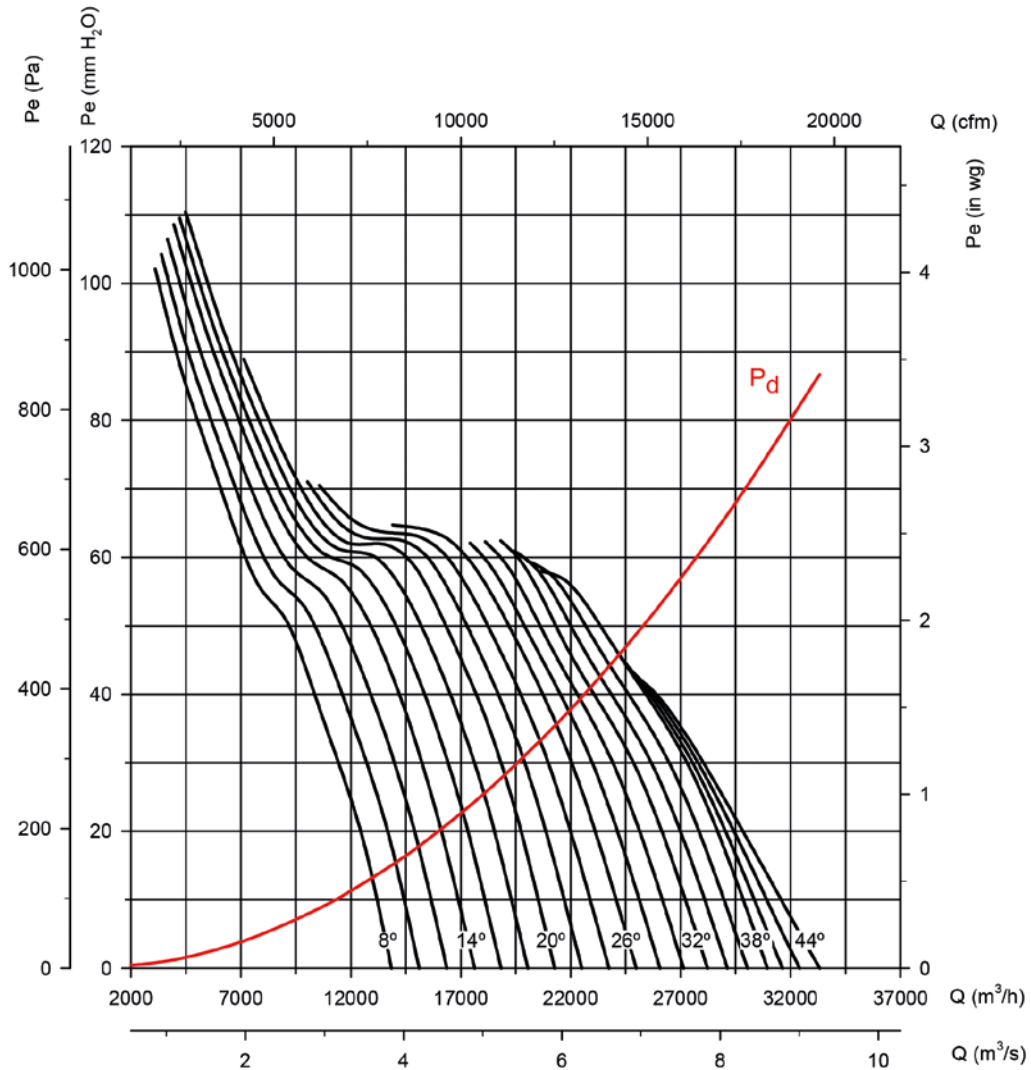

Characteristic curves

Q= Flow rate in m³/h, m³/s and cfm Pe= Static pressure in mm H₂O, Pa and inwg

Impeller diameter in cm: 56

Number of motor poles: 4

Number of blades: 6

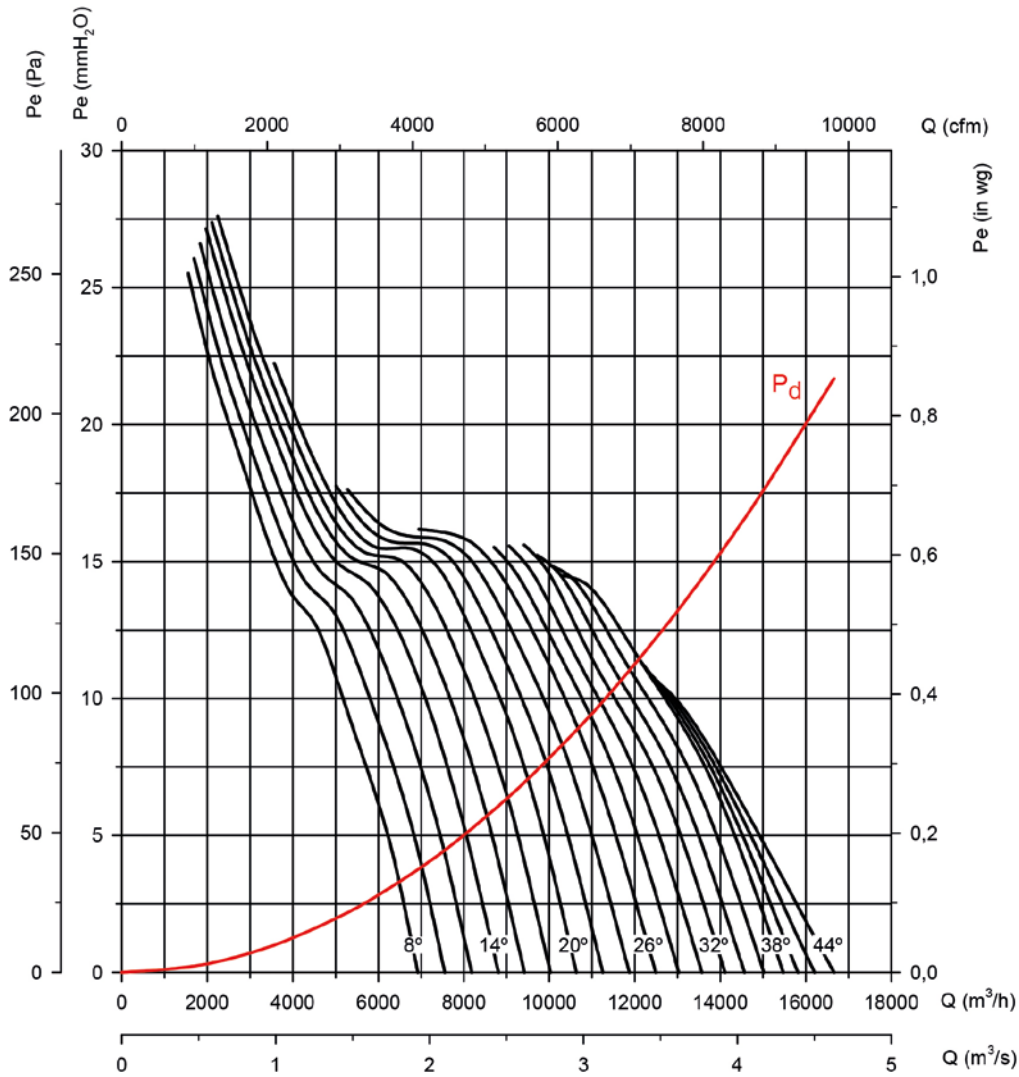

Absorbed power

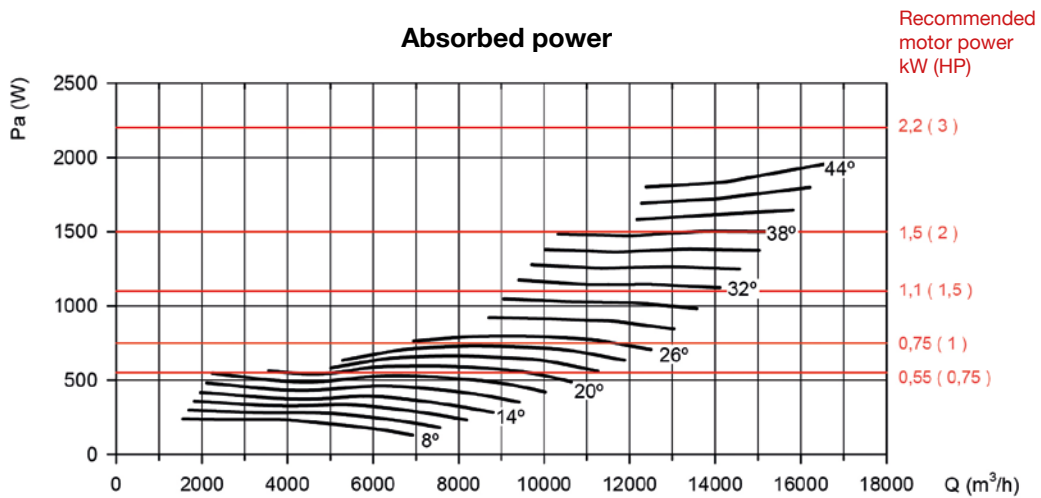

Characteristic curves

Q= Flow rate in m³/h, m³/s and cfm Pe= Static pressure in mm H₂O, Pa and inwg

Impeller diameter in cm: 56

Number of motor poles: 6

Number of blades: 6

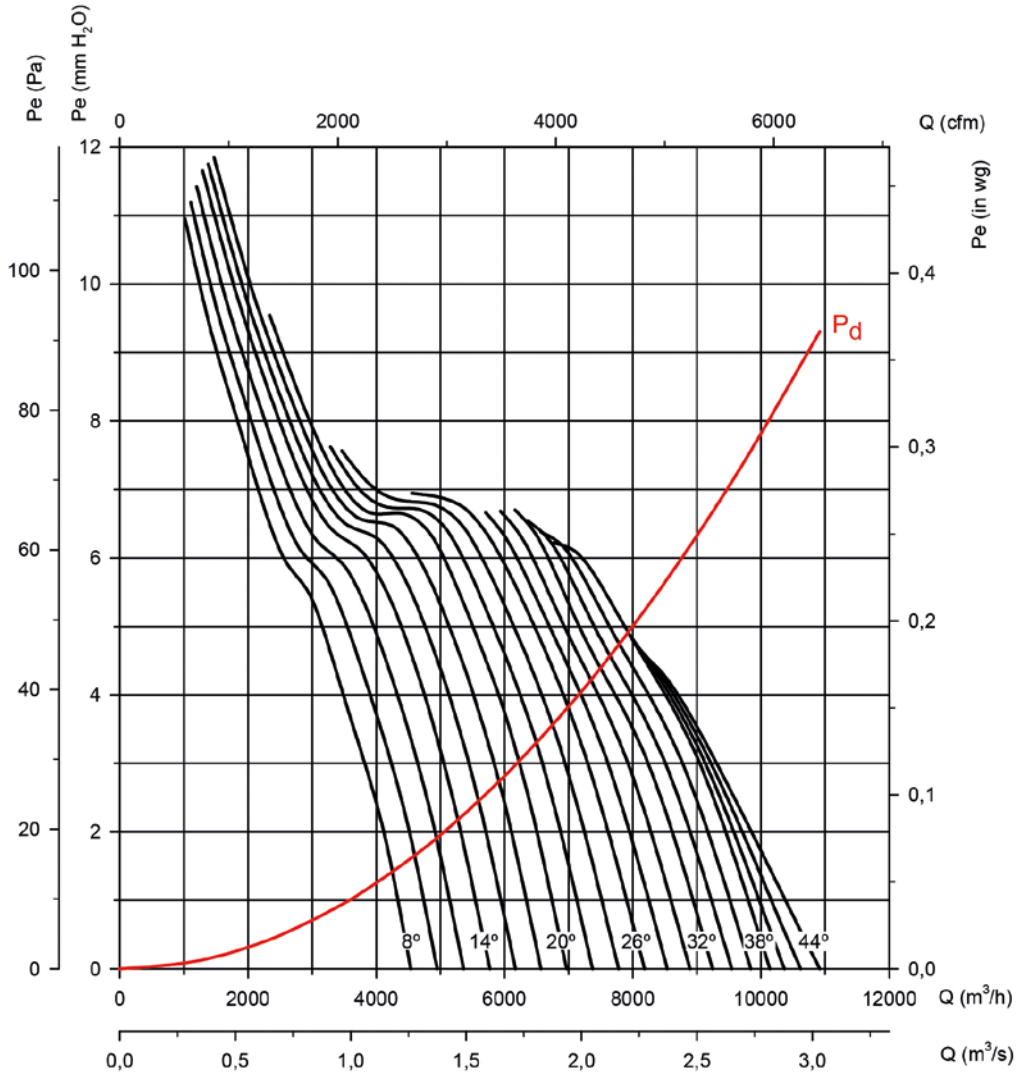

Absorbed power

Recommended motor power kW (HP)

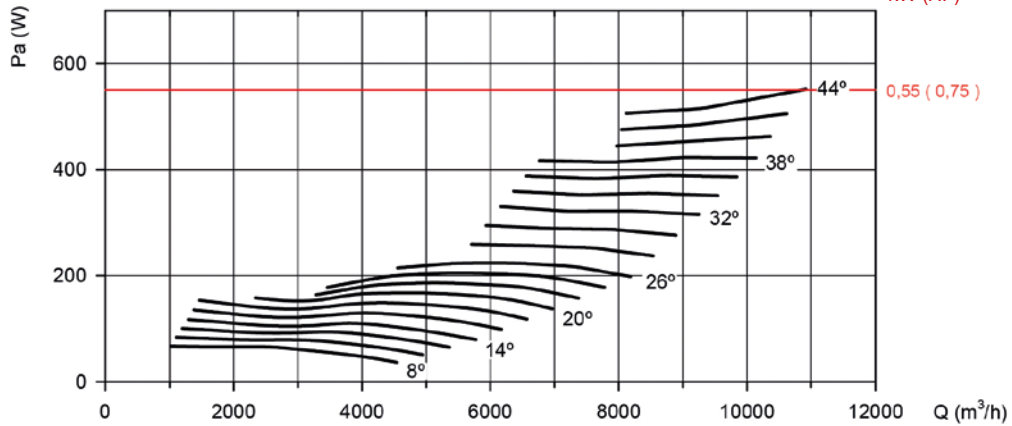

Characteristic curves

Q= Flow rate in m³/h, m³/s and cfm

Pe= Static pressure in mm H₂O, Pa and inwg

Impeller diameter in cm: 63

Number of motor poles: 2

Number of blades: 6

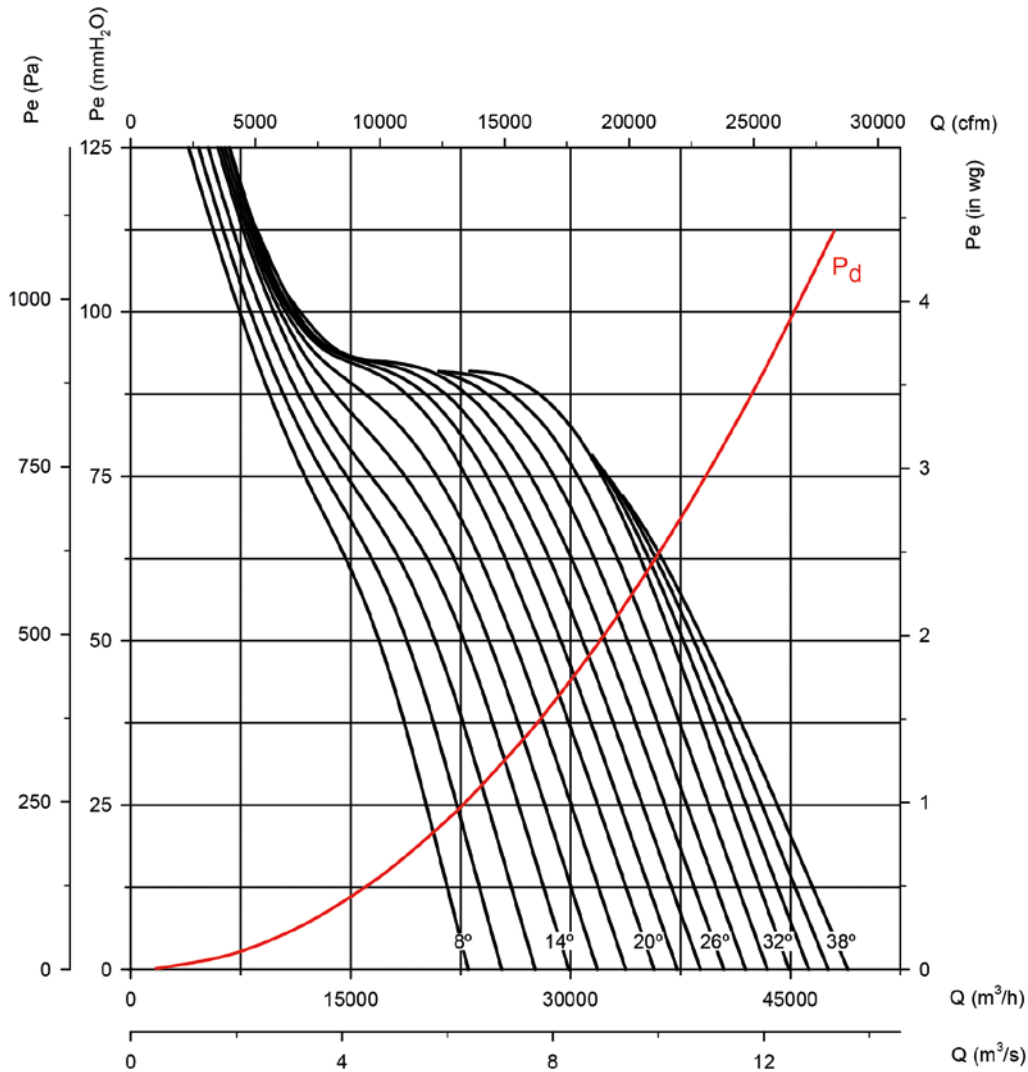

Absorbed power

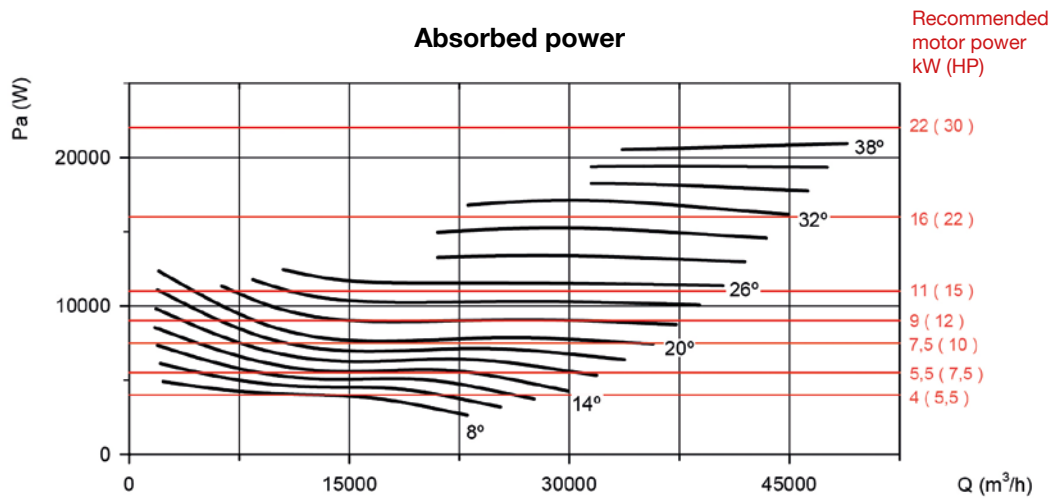

Characteristic curves

Q= Flow rate in m³/h, m³/s and cfm Pe= Static pressure in mm H₂O, Pa and inwg

Impeller diameter in cm: 63

Number of motor poles: 4

Number of blades: 6

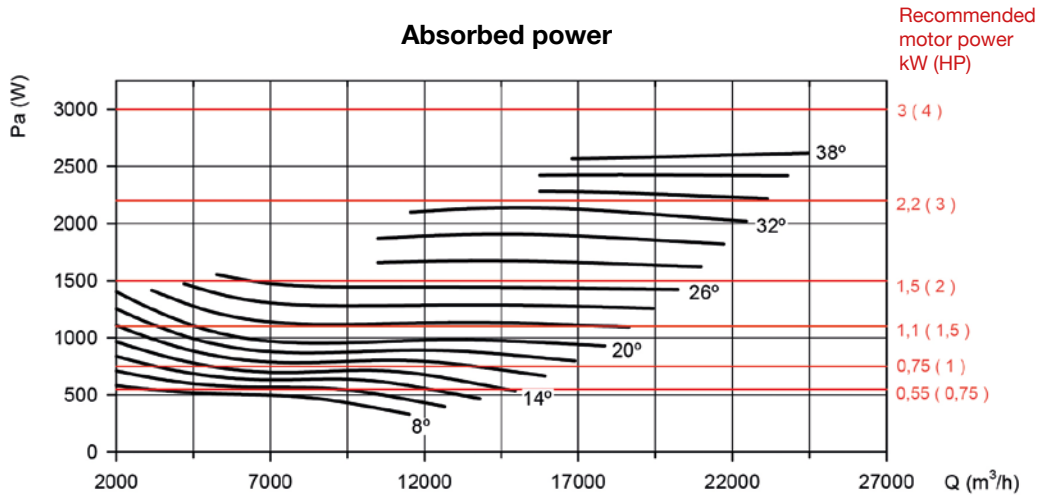
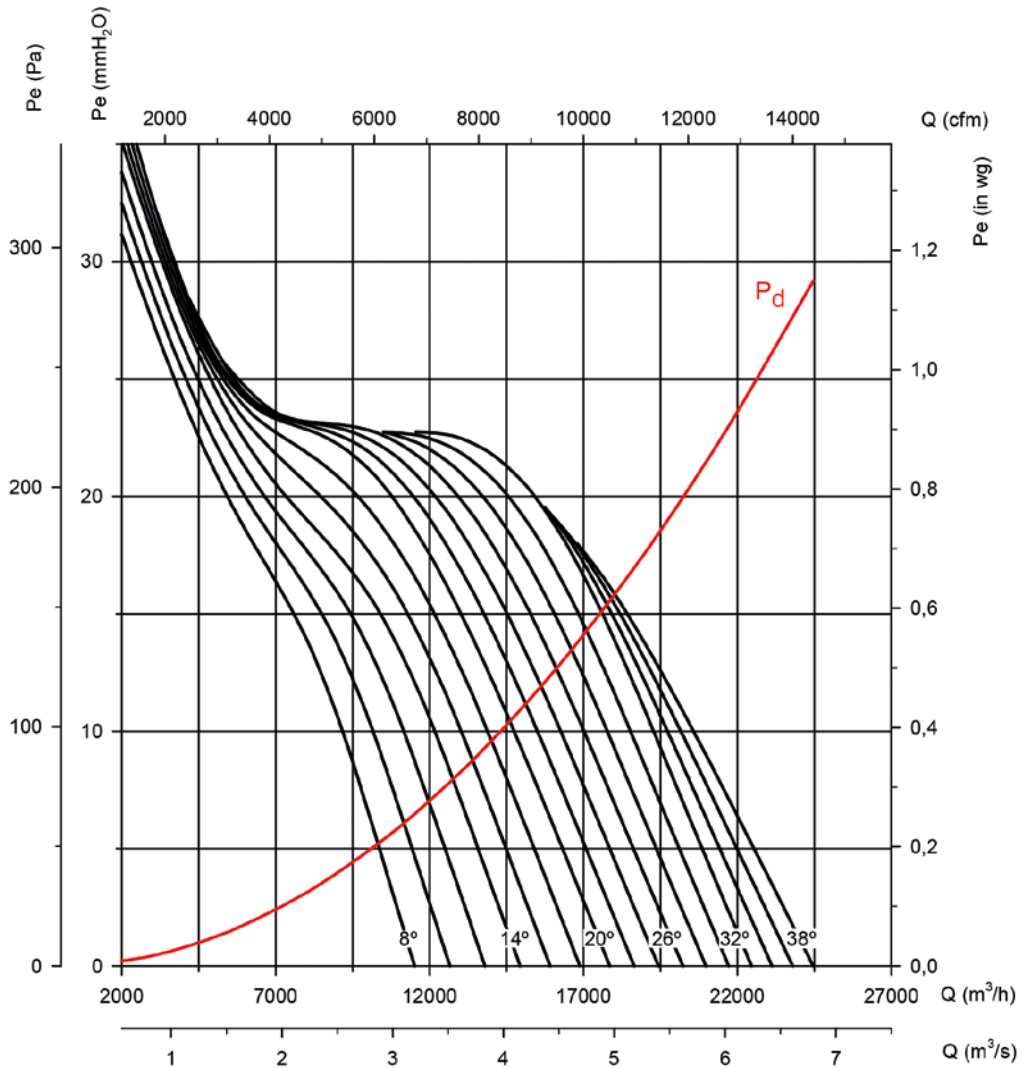

Characteristic curves

Q= Flow rate in m³/h, m³/s and cfm

Pe= Static pressure in mm H₂O, Pa and inwg

Impeller diameter in cm: 63

Number of motor poles: 6

Number of blades: 6

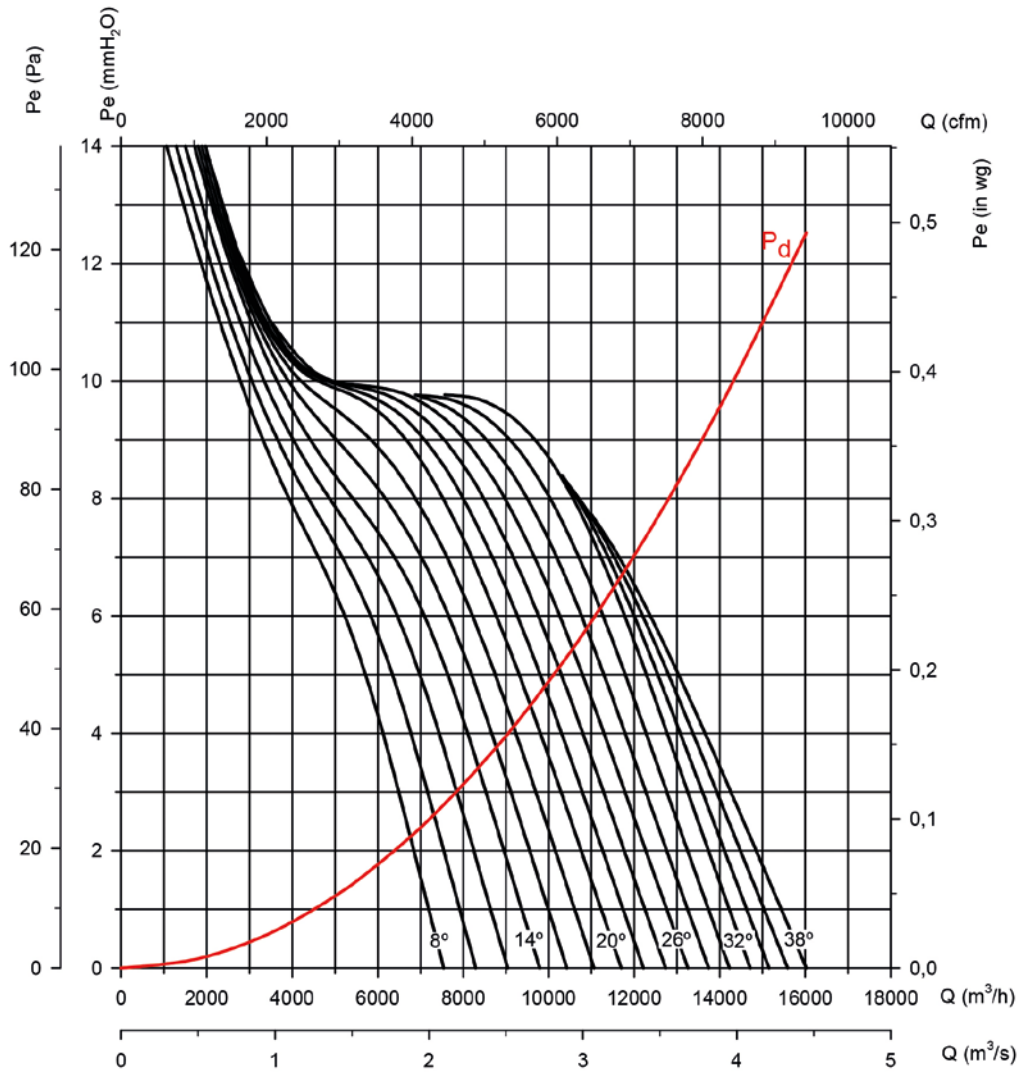

Absorbed power

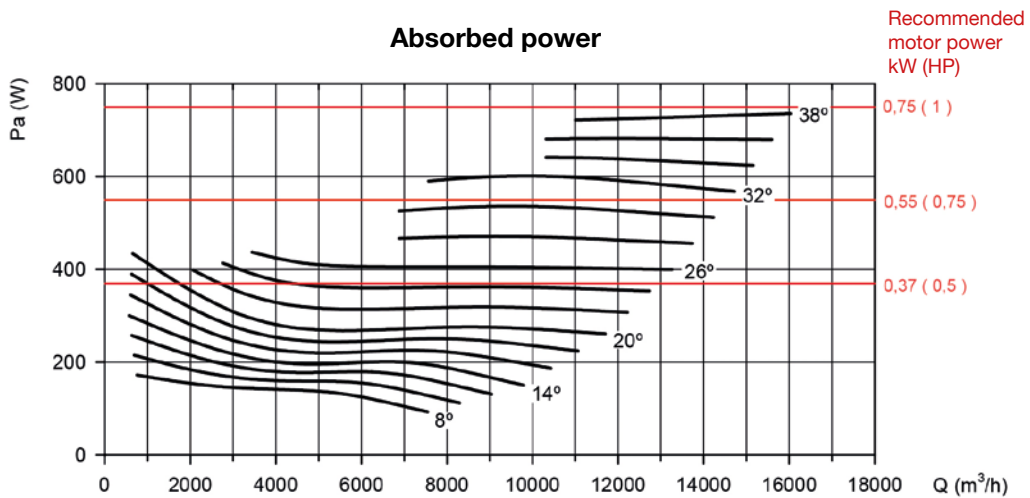

Characteristic curves

Q= Flow rate in m³/h, m³/s and cfm Pe= Static pressure in mm H₂O, Pa and inwg

Impeller diameter in cm: 71

Number of motor poles: 4

Number of blades: 6

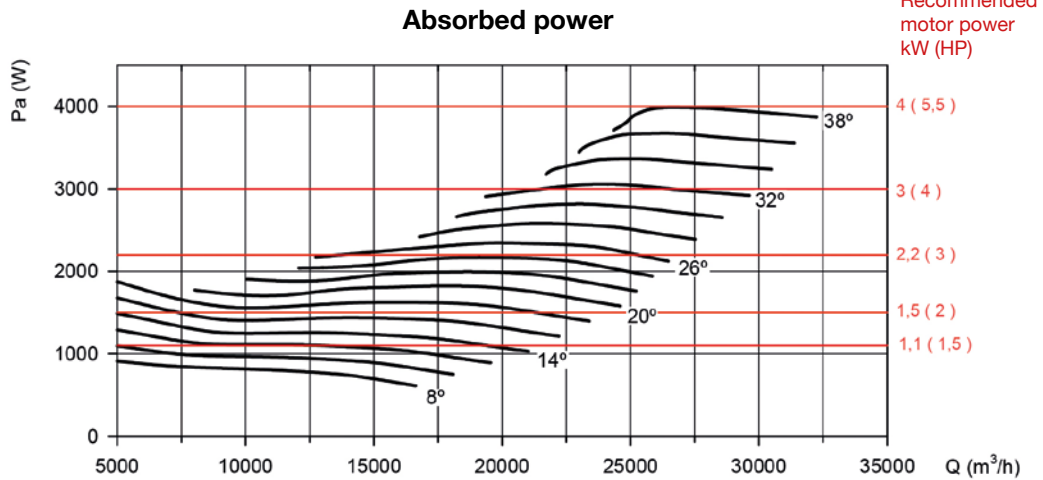
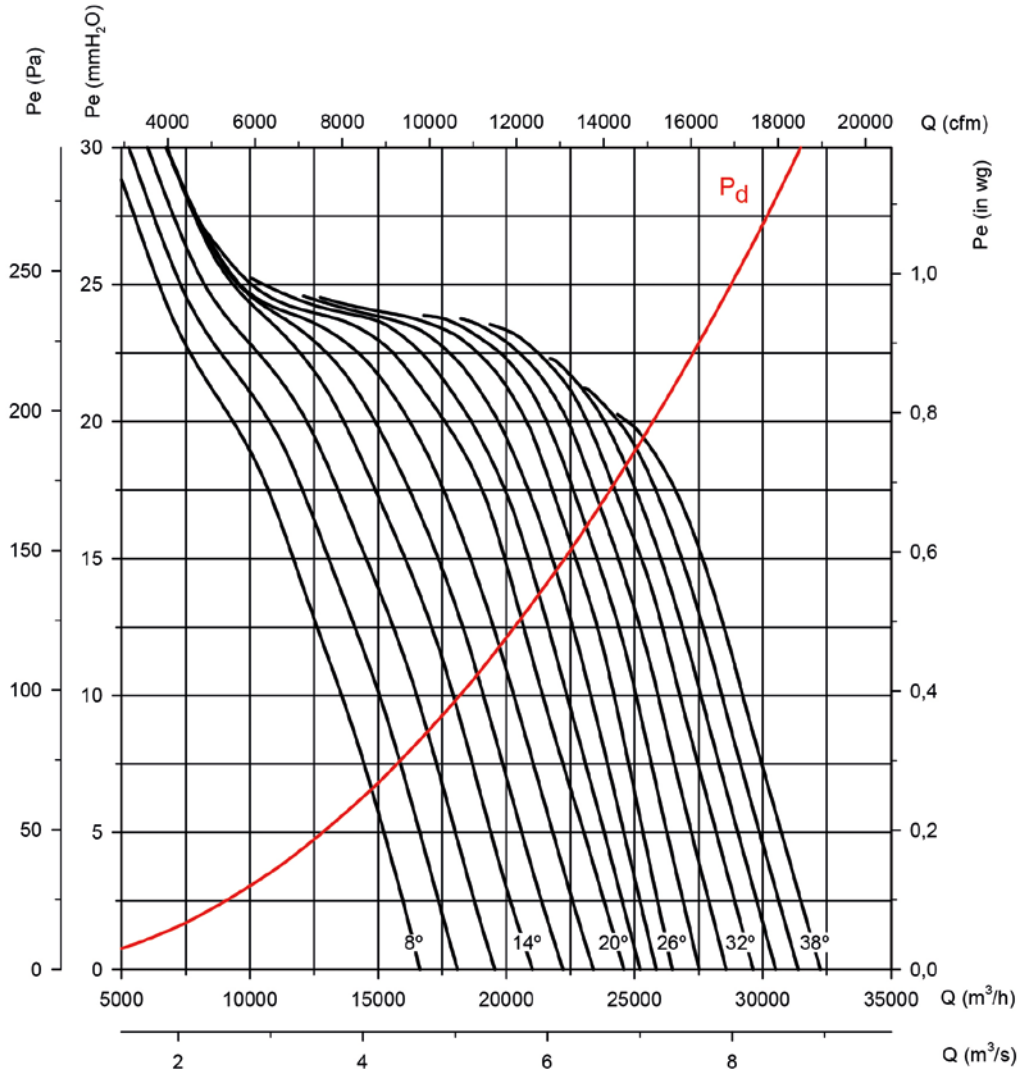

Characteristic curves

Q= Flow rate in m³/h, m³/s and cfm

Pe= Static pressure in mm H₂O, Pa and inwg

Impeller diameter in cm: 71

Number of motor poles: 6

Number of blades: 6

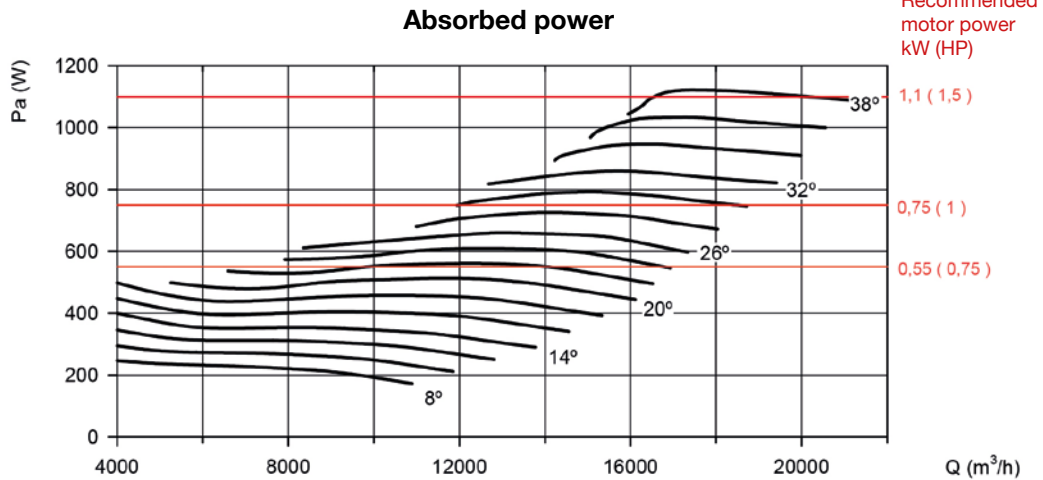
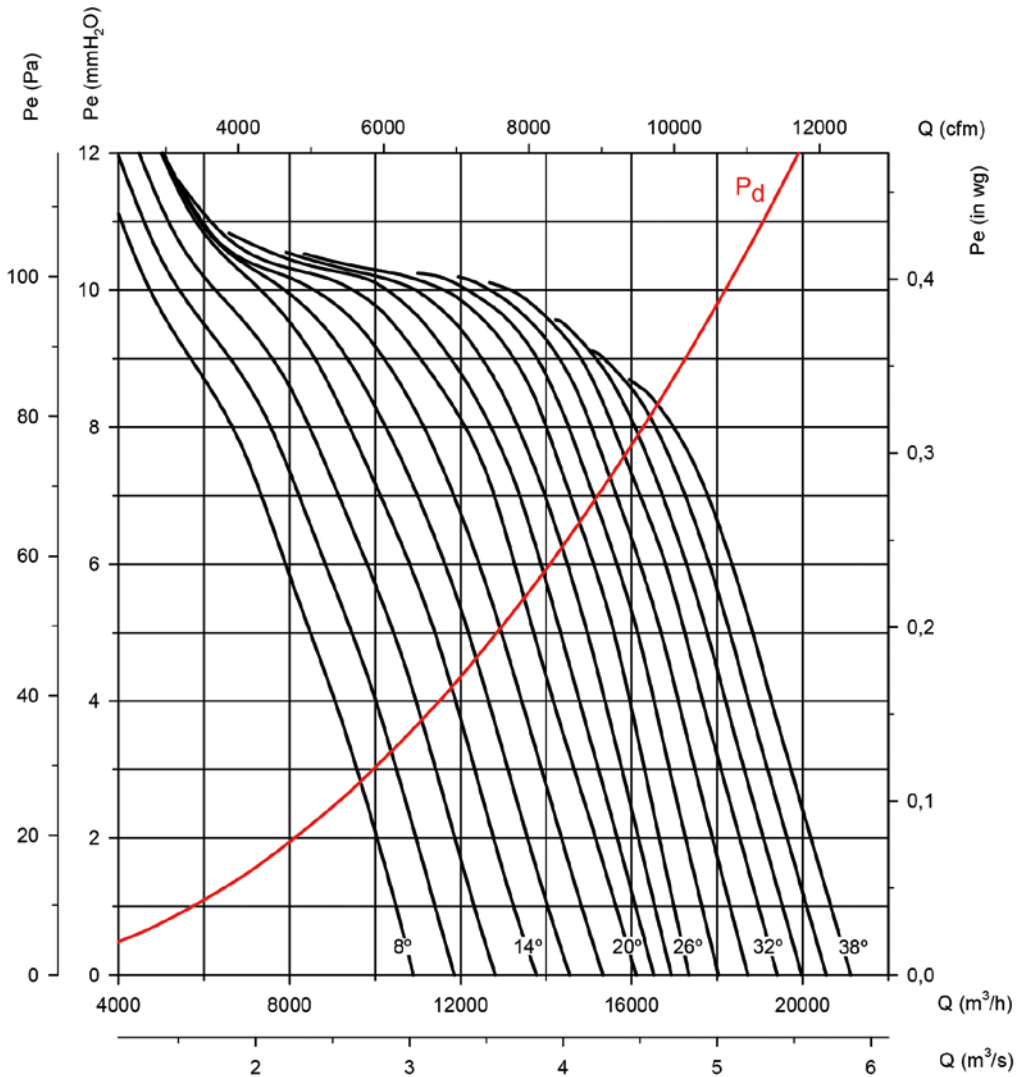

Characteristic curves

Q= Flow rate in m³/h, m³/s and cfm Pe= Static pressure in mm H₂O, Pa and inwg

Impeller diameter in cm: 80

Number of motor poles: 4

Number of blades: 6

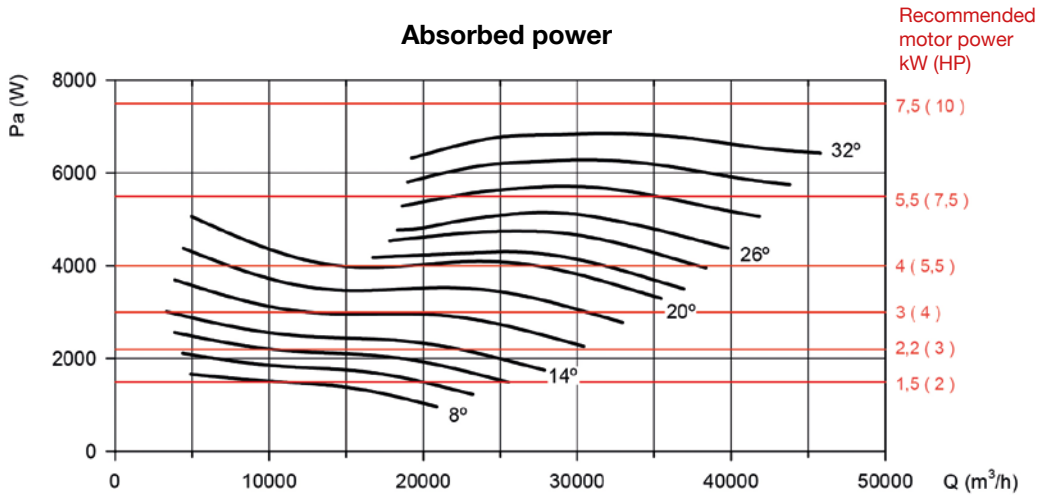
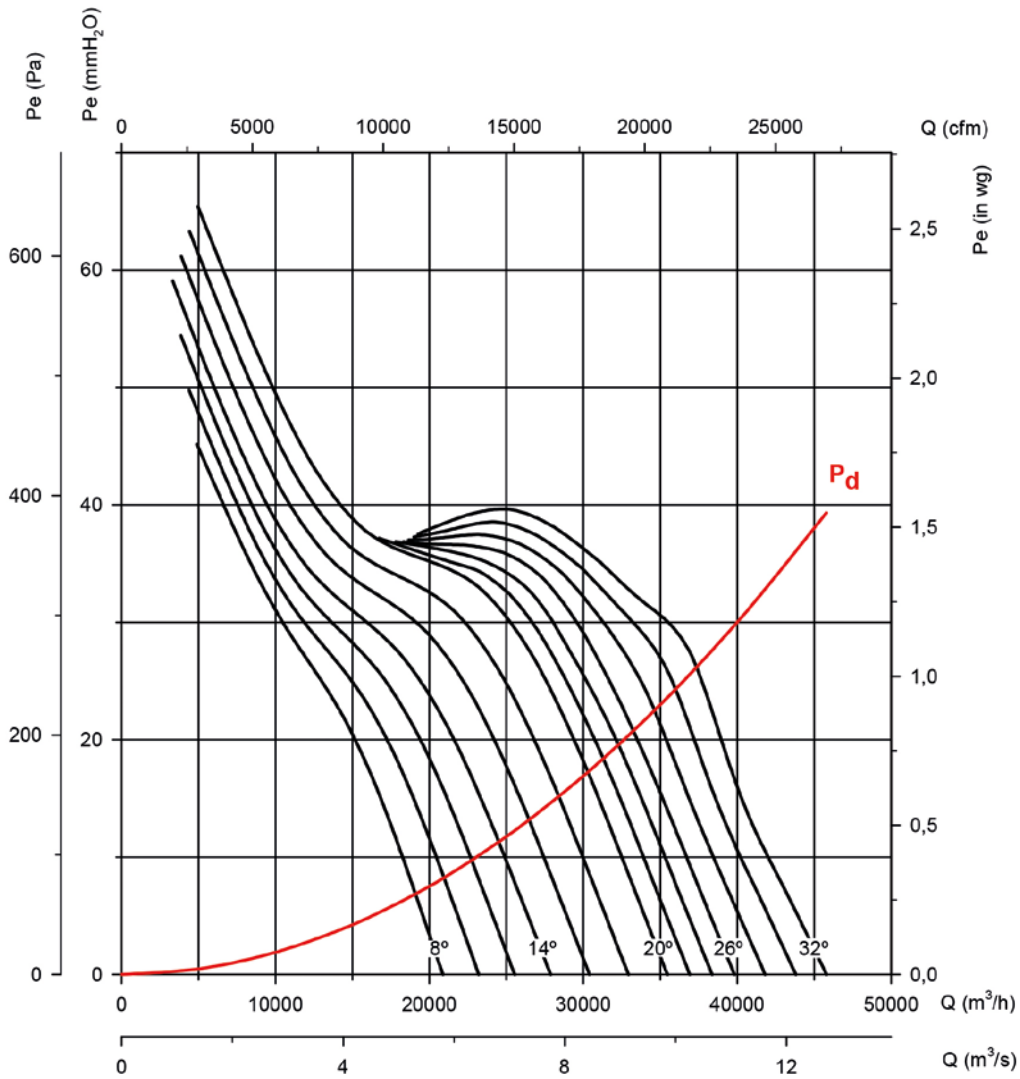

Characteristic curves

Q= Flow rate in m³/h, m³/s and cfm

Pe= Static pressure in mm H₂O, Pa and inwg

Impeller diameter in cm: 80

Number of motor poles: 6

Number of blades: 6

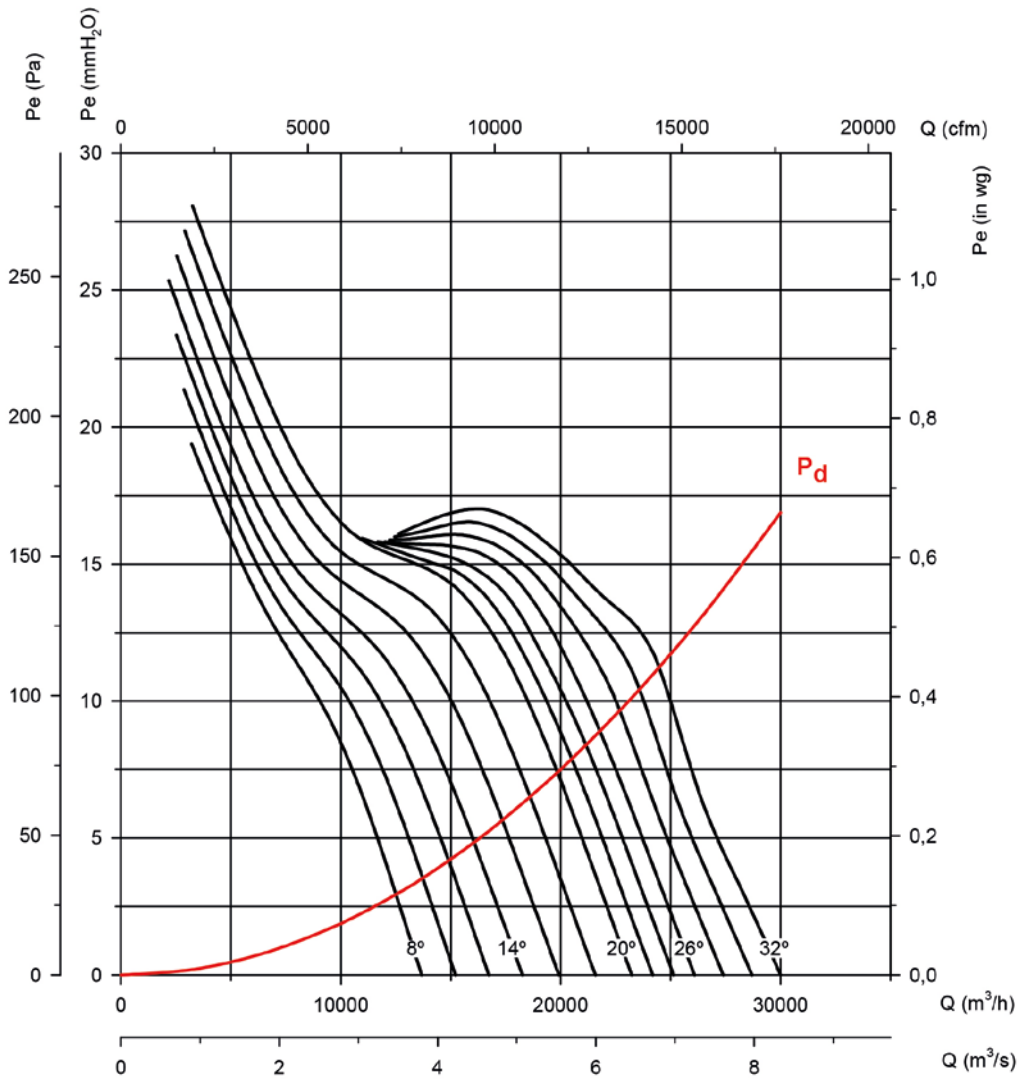

Absorbed power

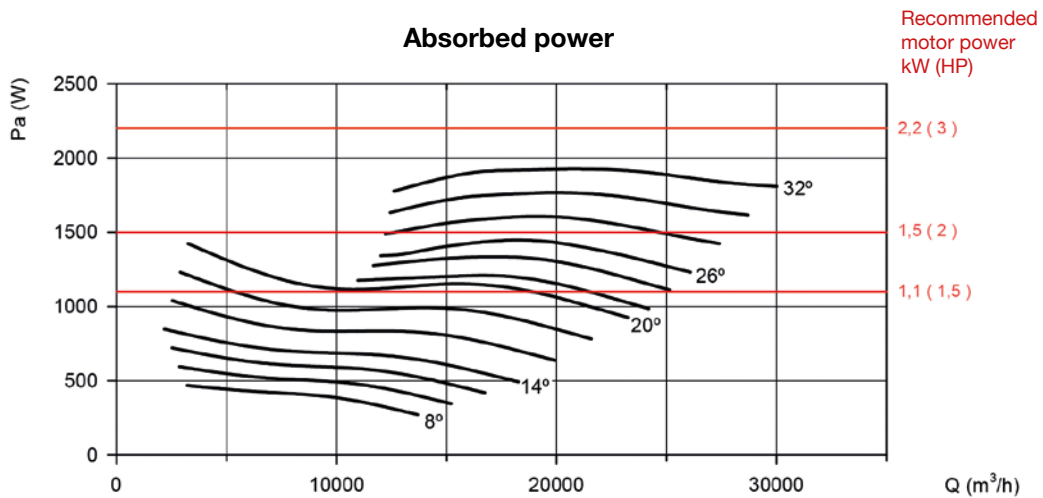

Characteristic curves

Q= Flow rate in m³/h, m³/s and cfm Pe= Static pressure in mm H₂O, Pa and inwg

Impeller diameter in cm: 80

Number of motor poles: 8

Number of blades: 6

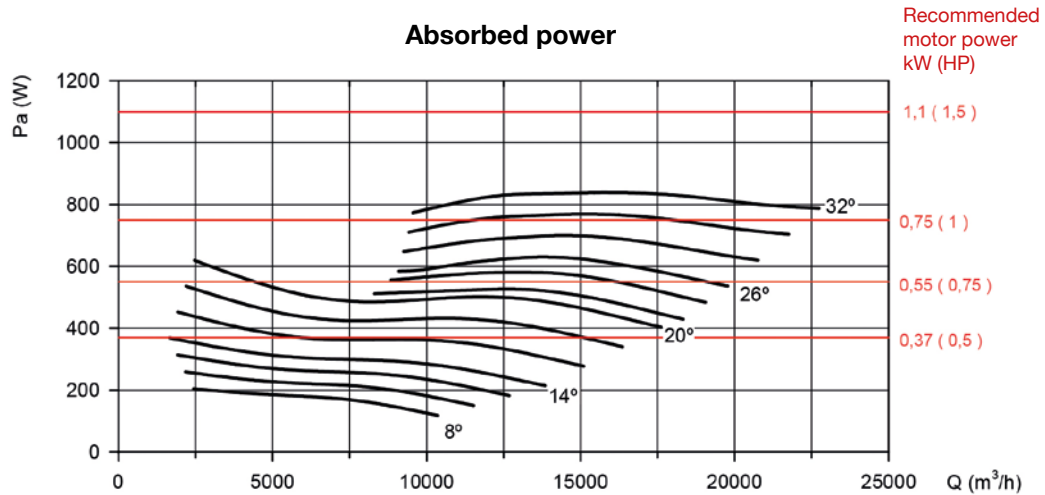
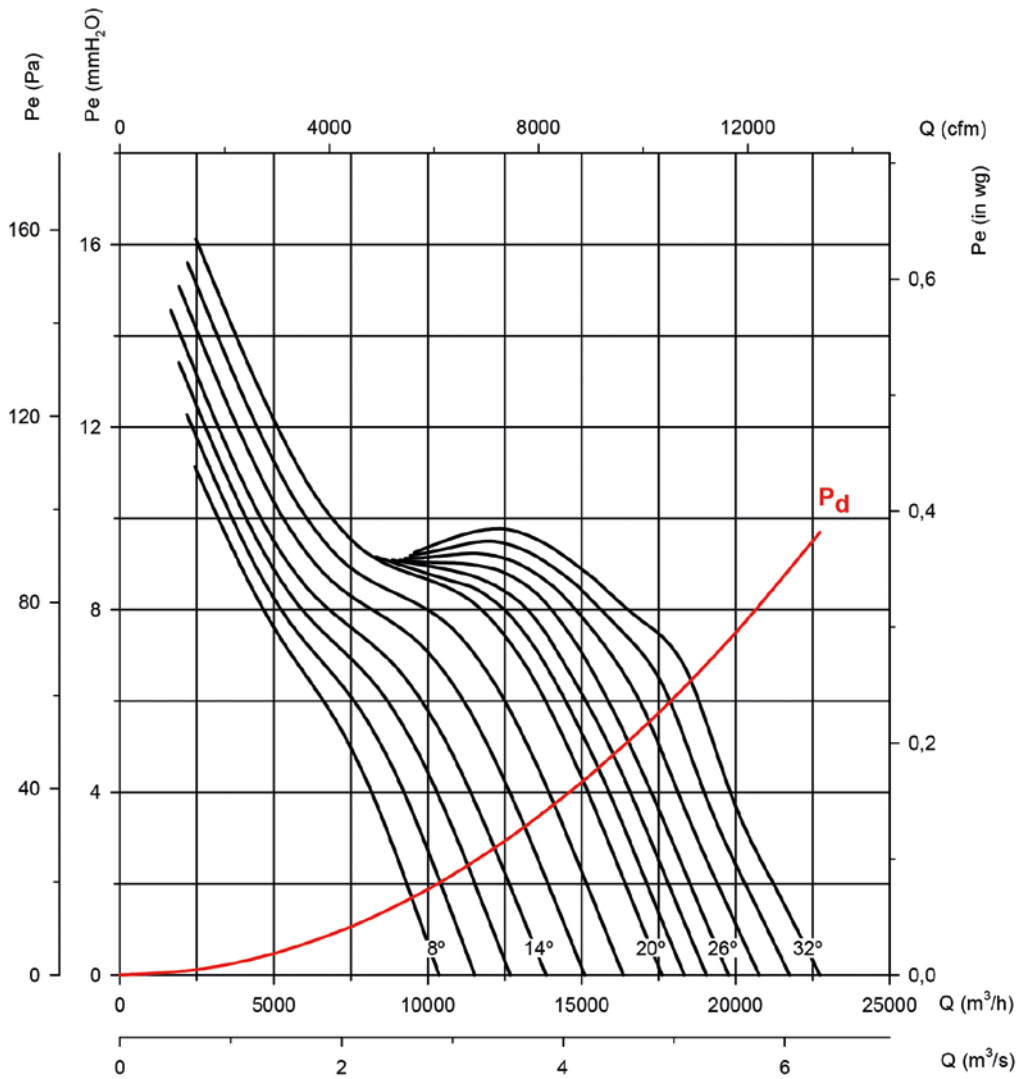

Characteristic curves

Q= Flow rate in m³/h, m³/s and cfm

Pe= Static pressure in mm H₂O, Pa and inwg

Impeller diameter in cm: 90

Number of motor poles: 4

Number of blades: 6

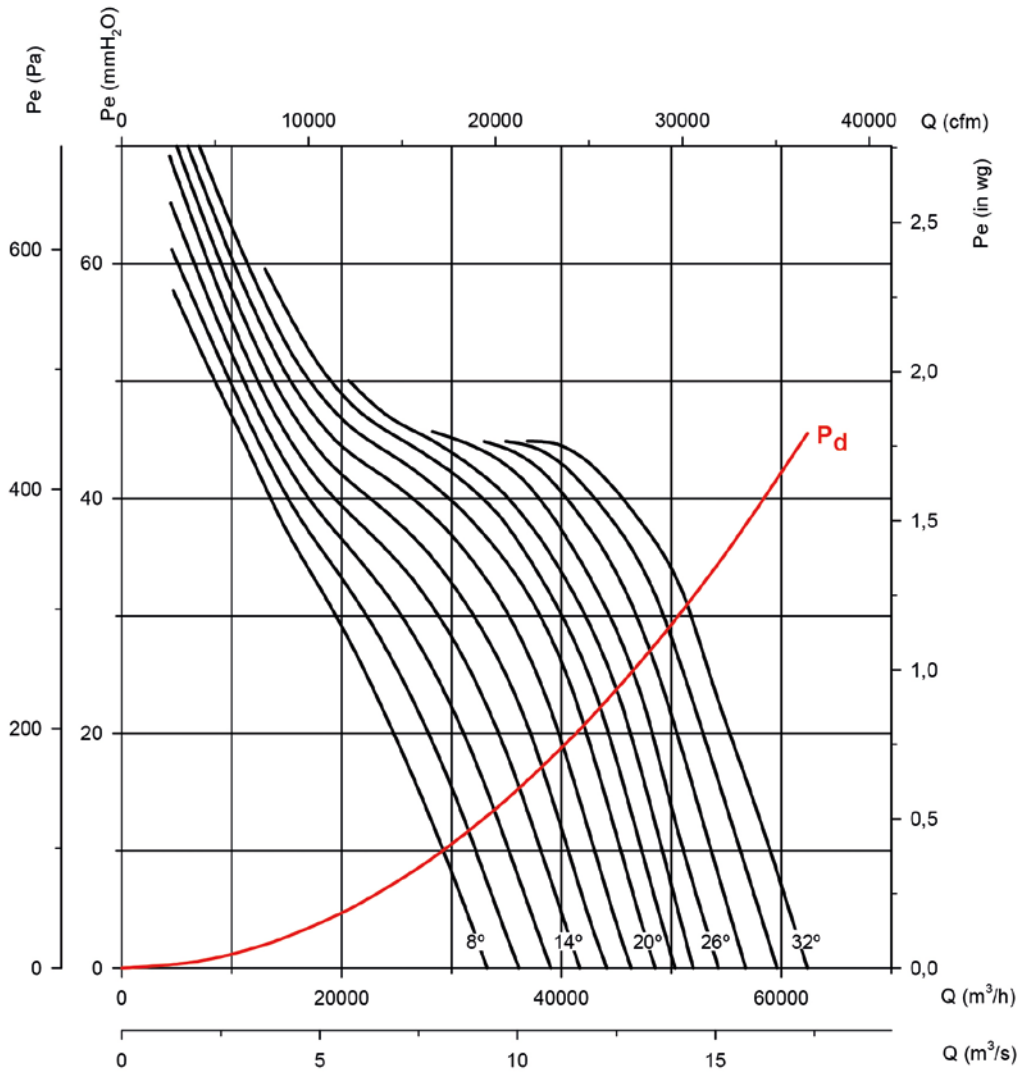

Absorbed power

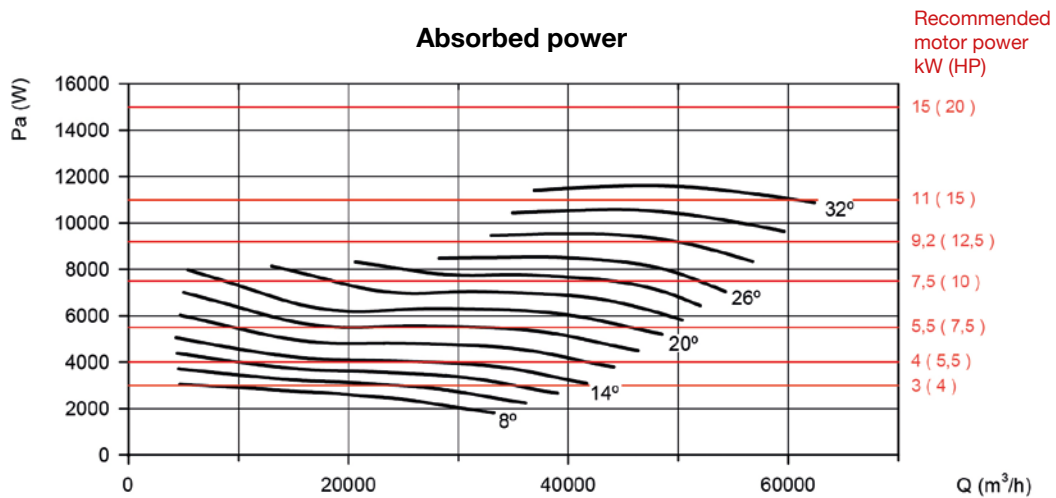

Characteristic curves

Q= Flow rate in m³/h, m³/s and cfm Pe= Static pressure in mm H₂O, Pa and inwg

Impeller diameter in cm: 90

Number of motor poles: 6

Number of blades: 6

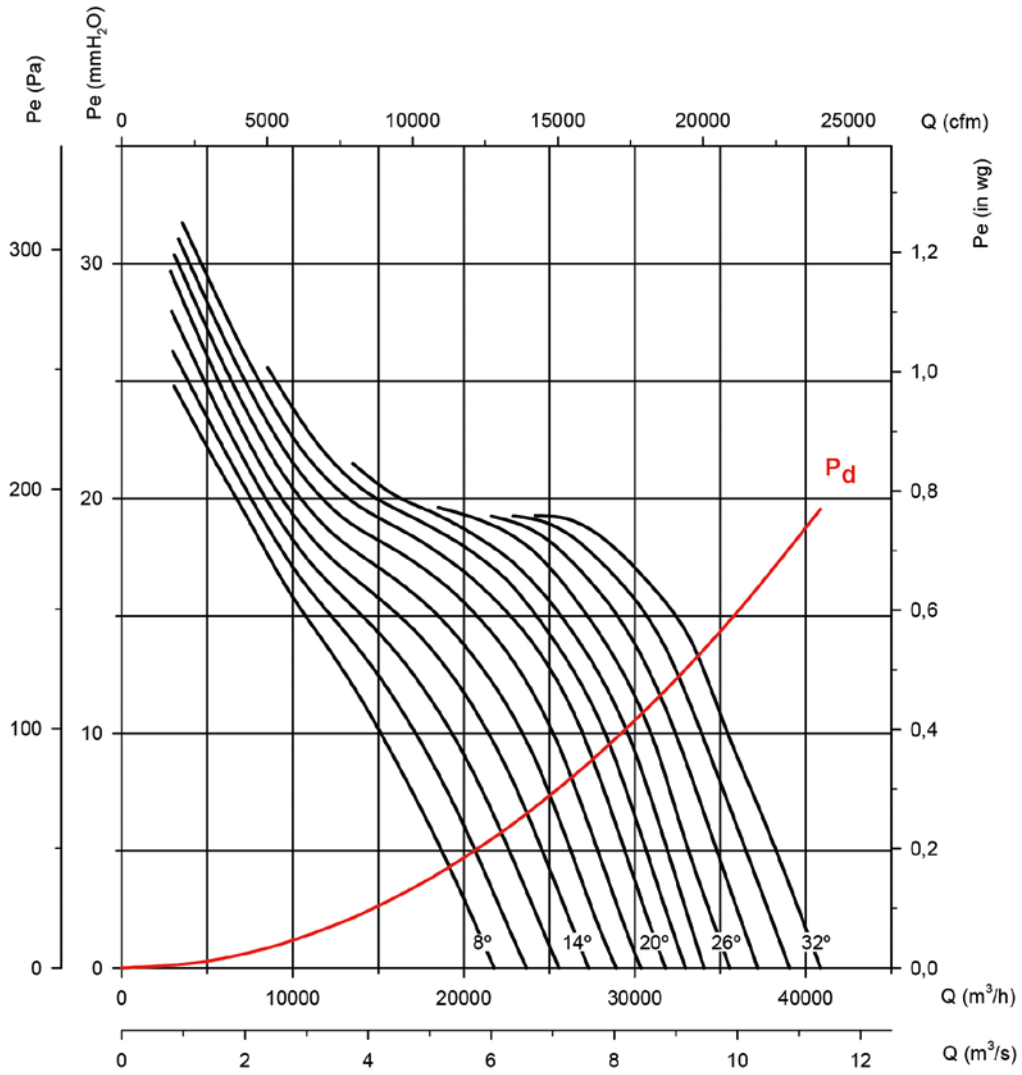

Absorbed power

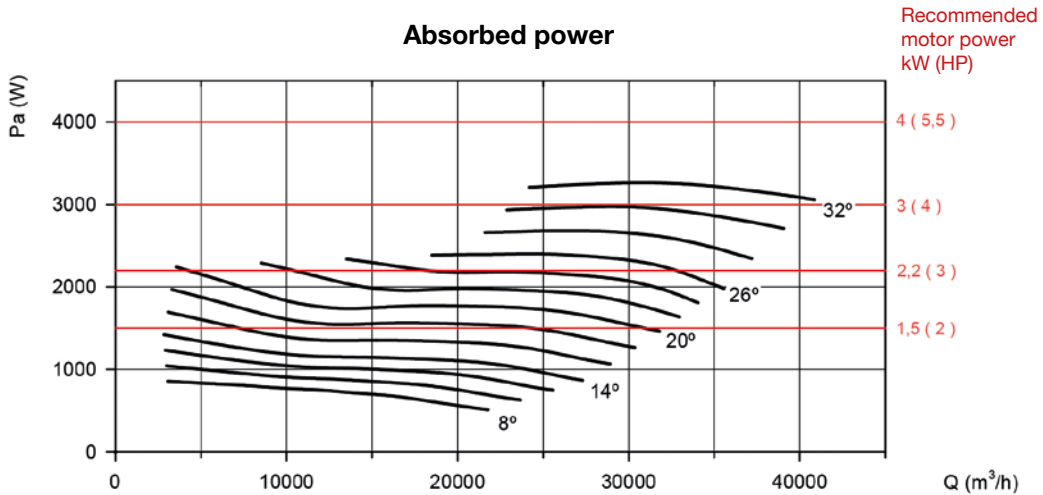

Characteristic curves

Q= Flow rate in m³/h, m³/s and cfm

Pe= Static pressure in mm H₂O, Pa and inwg

Impeller diameter in cm: 90

Number of motor poles: 8

Number of blades: 6

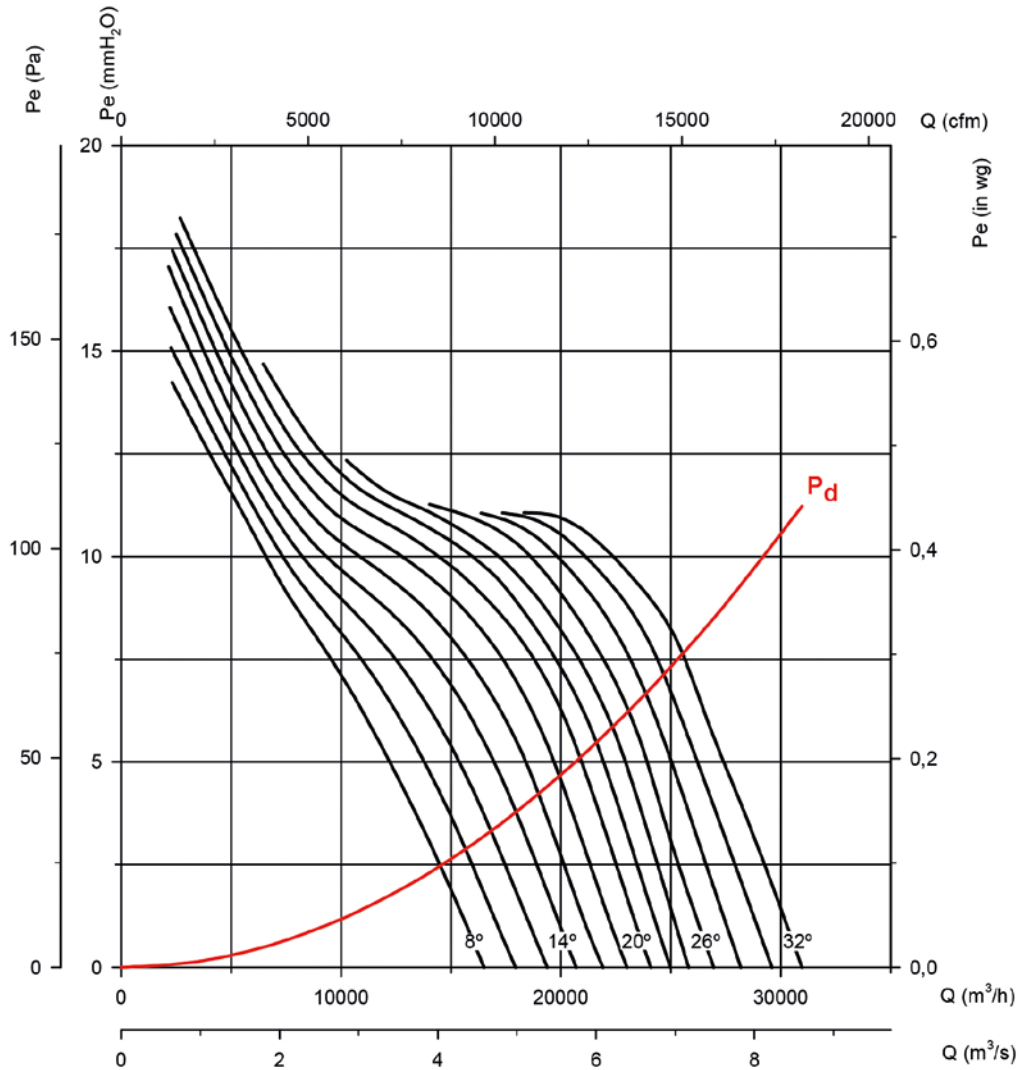

Absorbed power

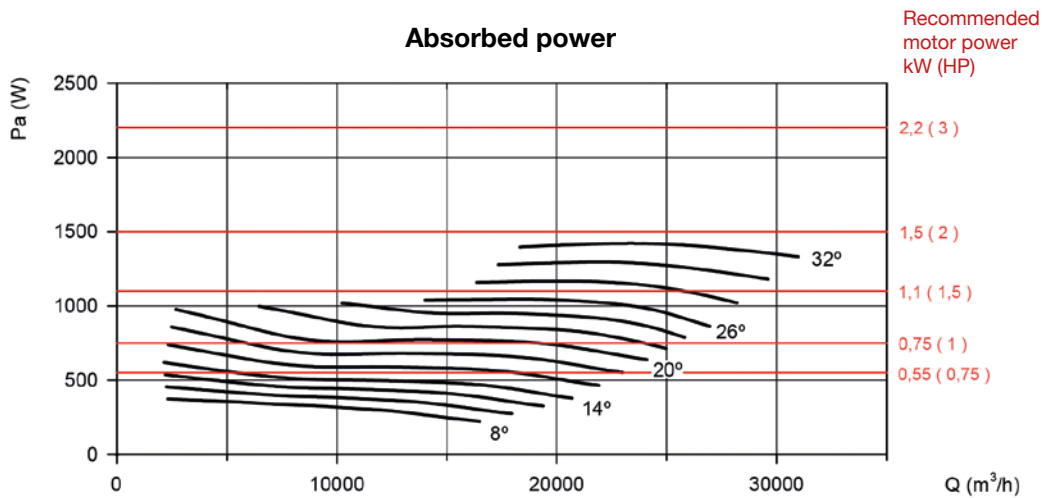

Characteristic curves

Q= Flow rate in m³/h, m³/s and cfm Pe= Static pressure in mm H₂O, Pa and inwg

Impeller diameter in cm: 100

Number of motor poles: 4

Number of blades: 6

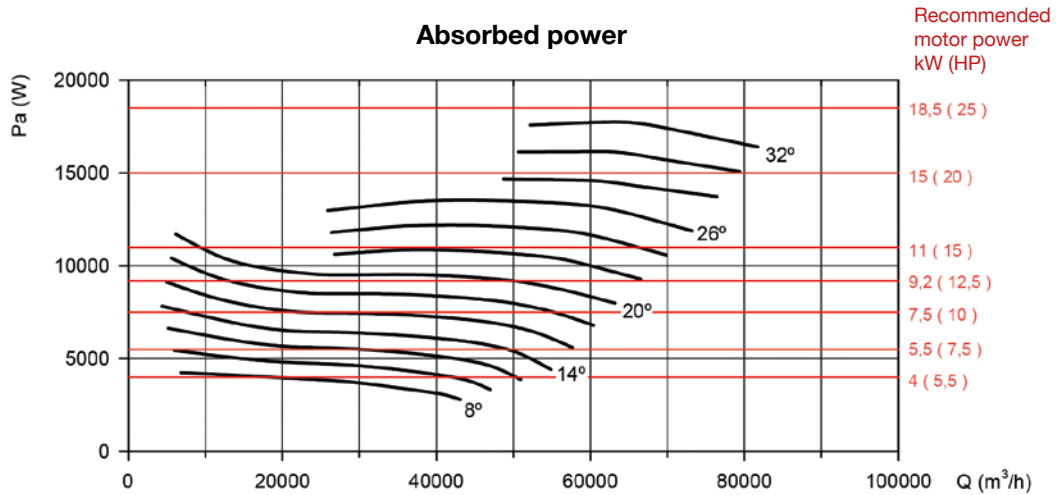
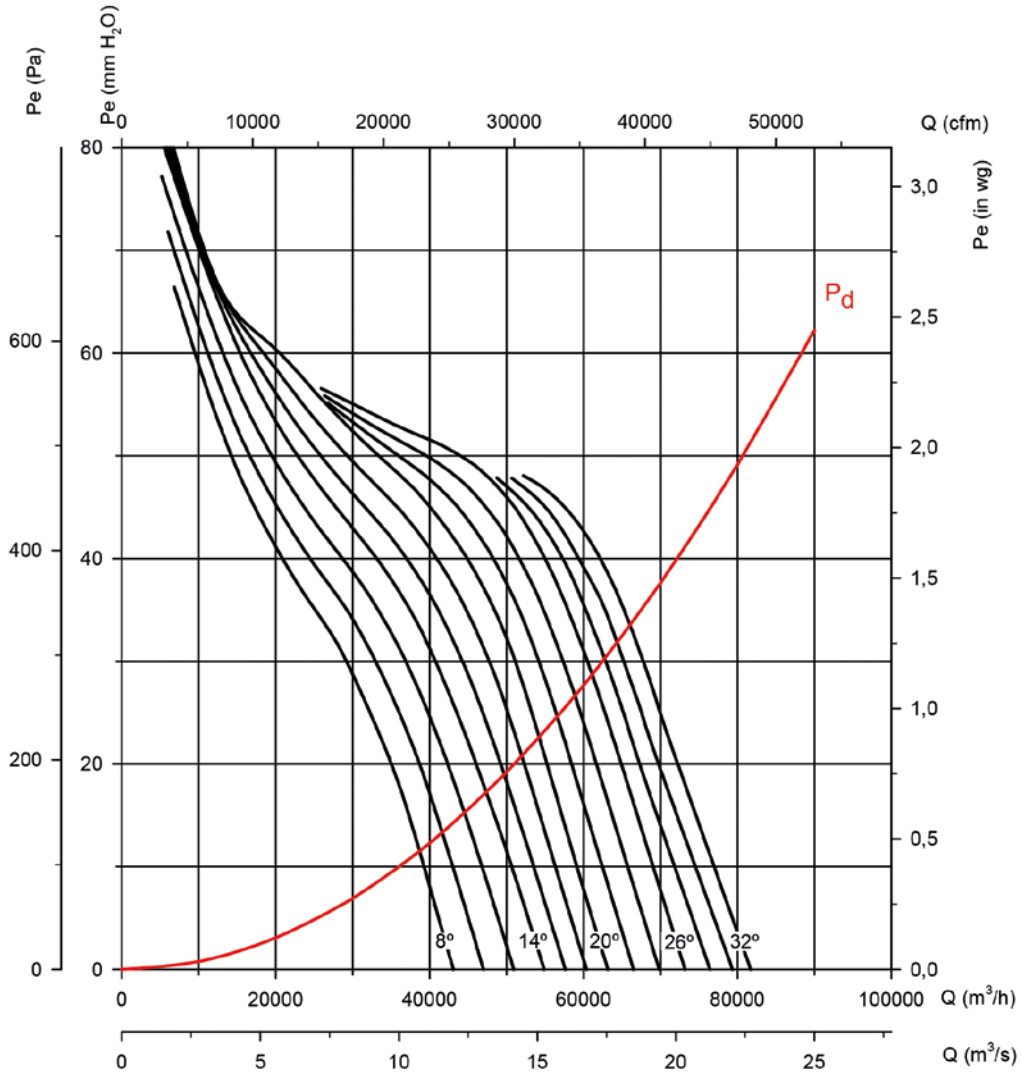

Characteristic curves

Q= Flow rate in m³/h, m³/s and cfm

Pe= Static pressure in mm H₂O, Pa and inwg

Impeller diameter in cm: 100

Number of motor poles: 4

Number of blades: 9

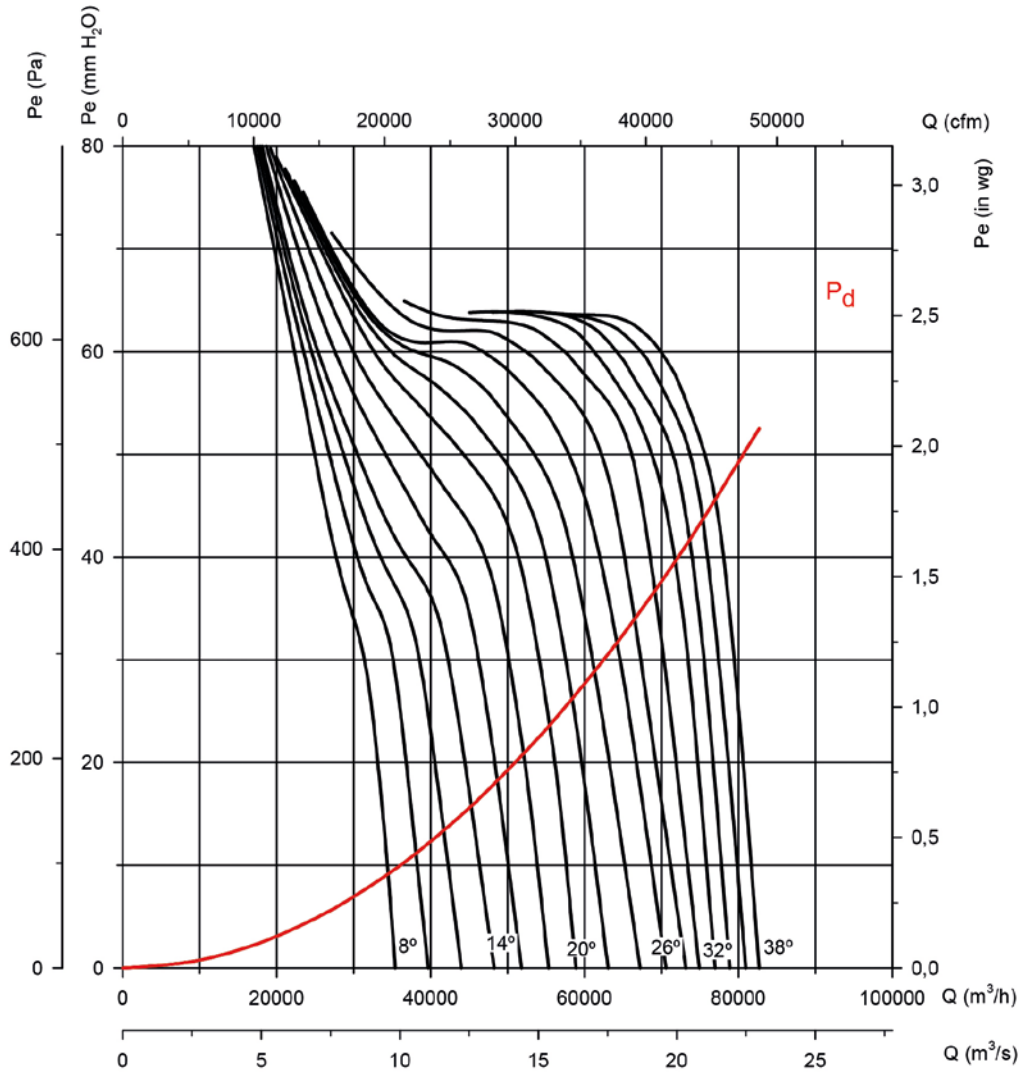

Absorbed power

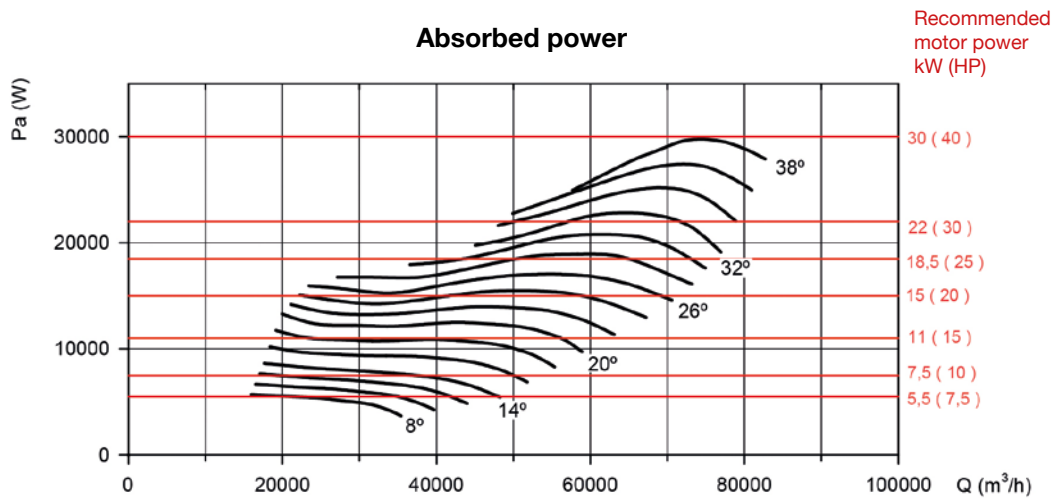

Characteristic curves

Q= Flow rate in m³/h, m³/s and cfm Pe= Static pressure in mm H₂O, Pa and inwg

Impeller diameter in cm: 100

Number of motor poles: 6

Number of blades: 6

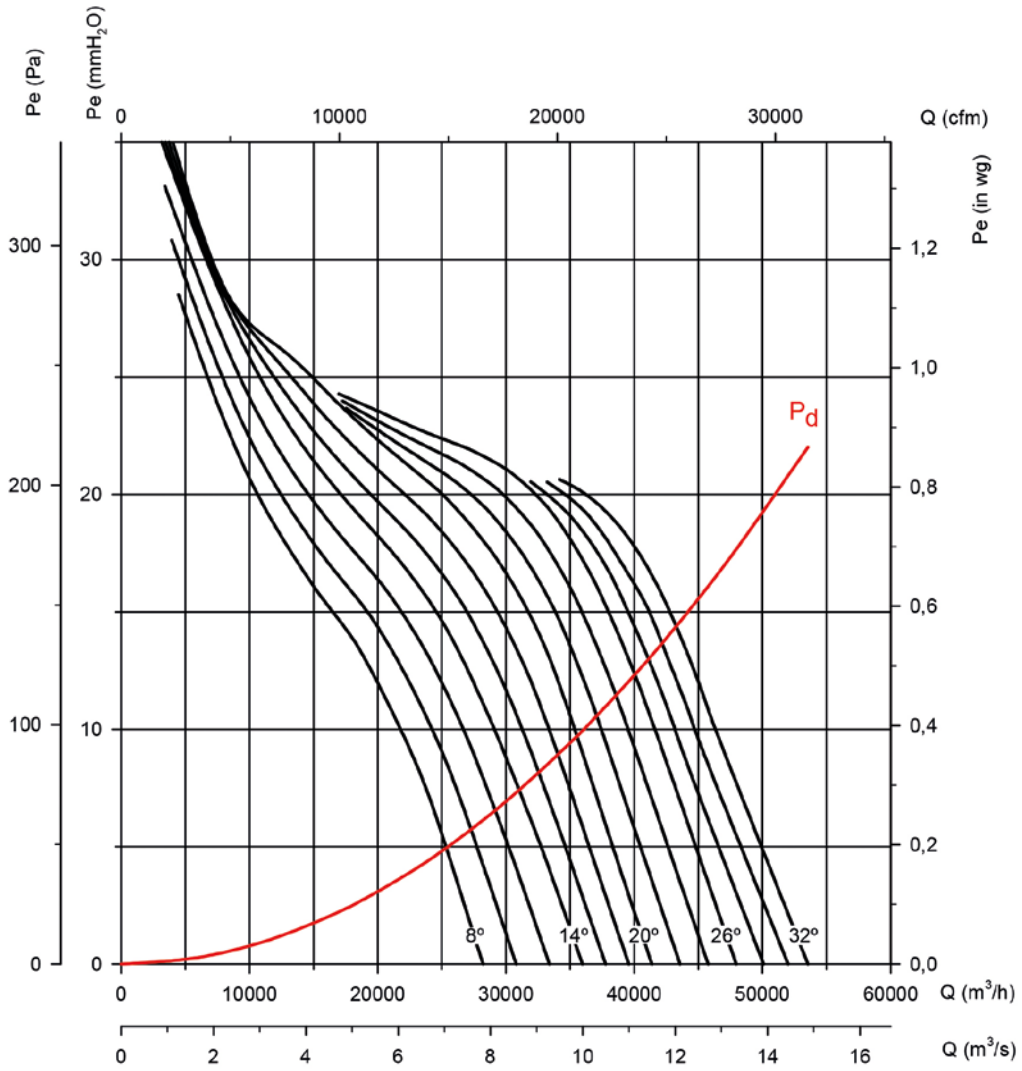

Absorbed power

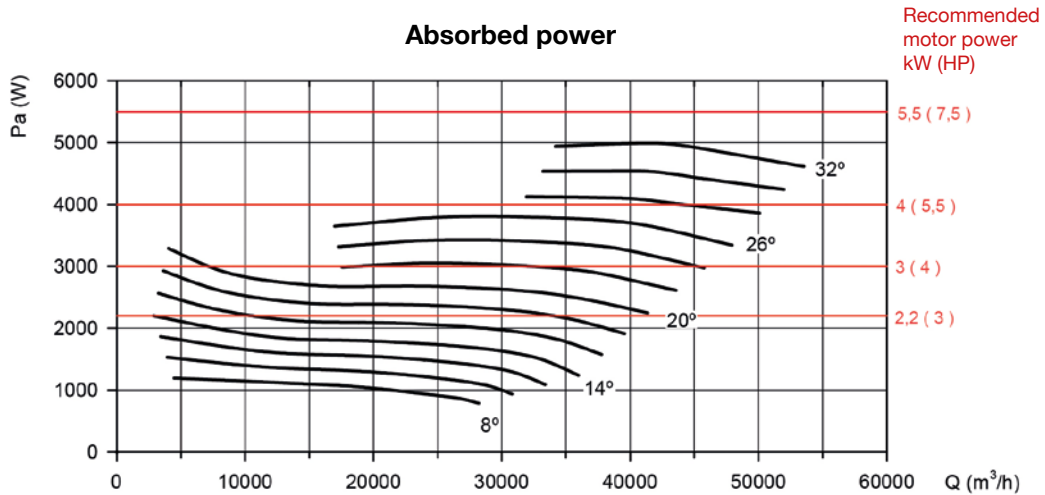

Characteristic curves

Q= Flow rate in m³/h, m³/s and cfm

Pe= Static pressure in mm H₂O, Pa and inwg

Impeller diameter in cm: 100

Number of motor poles: 6

Number of blades: 9

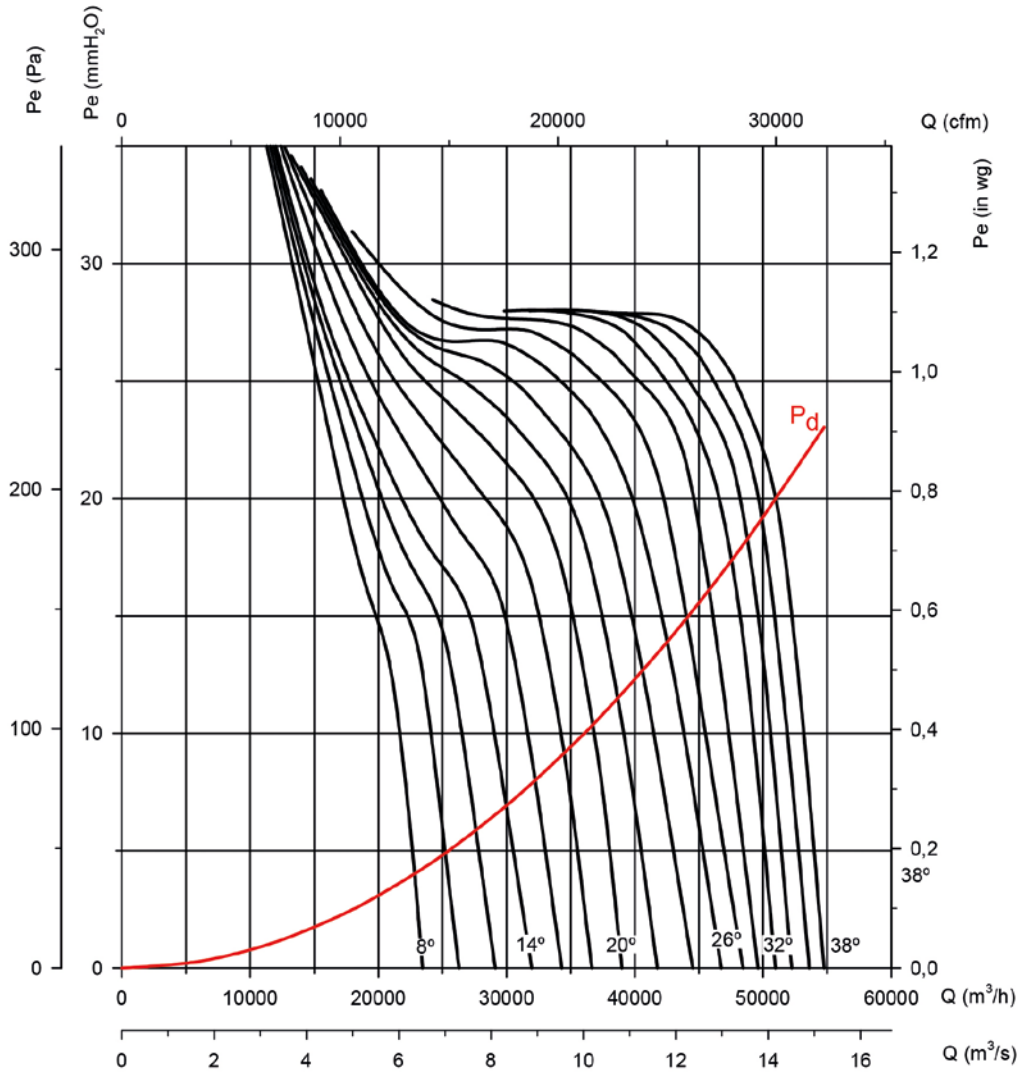

Absorbed power

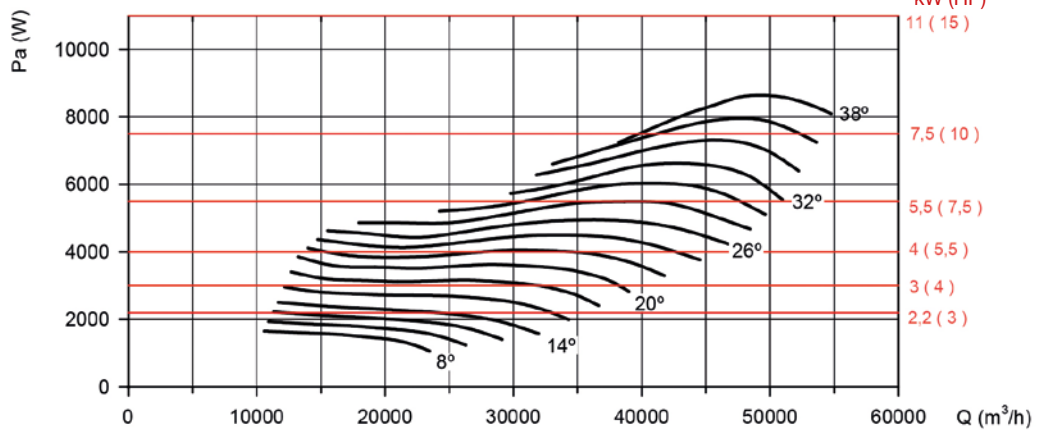

Characteristic curves

Q= Flow rate in m³/h, m³/s and cfm Pe= Static pressure in mm H₂O, Pa and inwg

Impeller diameter in cm: 100

Number of motor poles: 8

Number of blades: 6

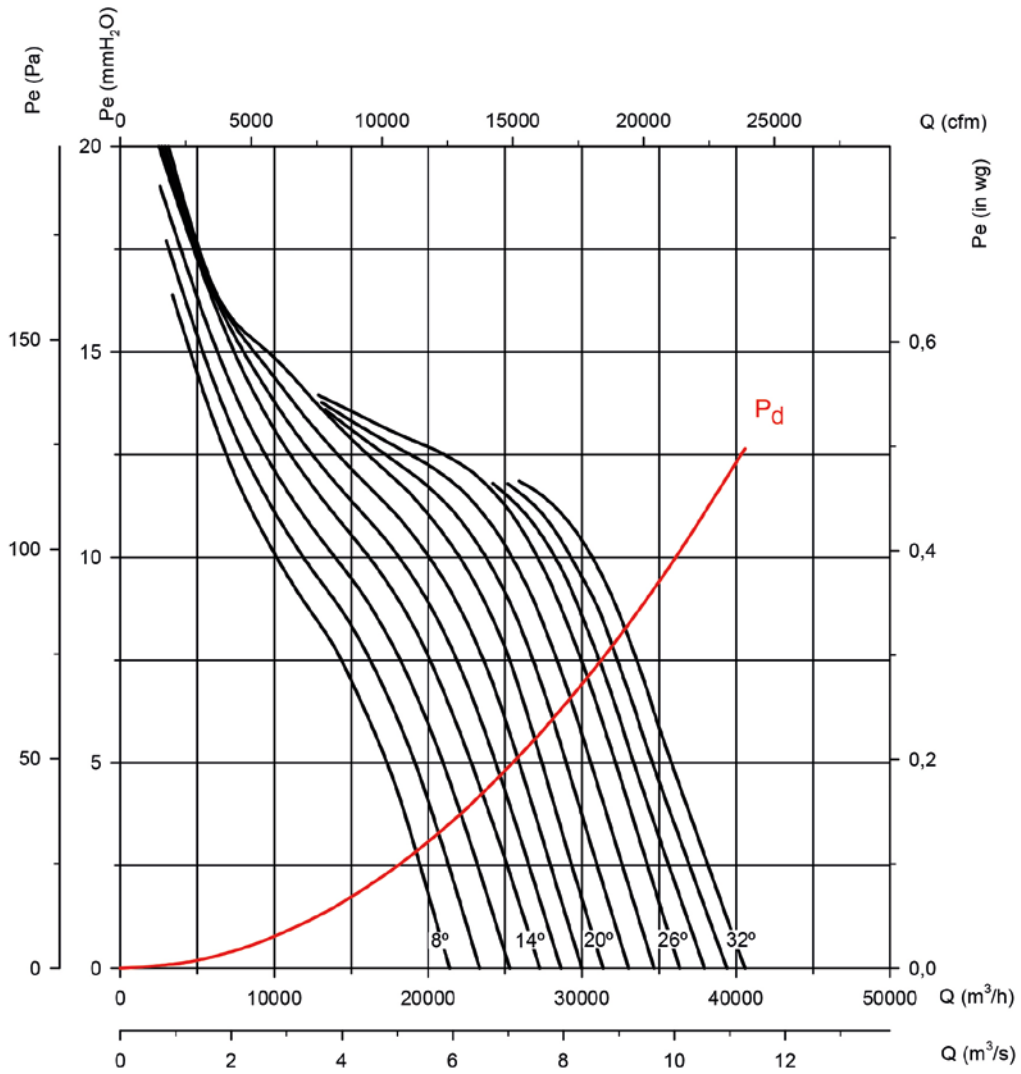

Absorbed power

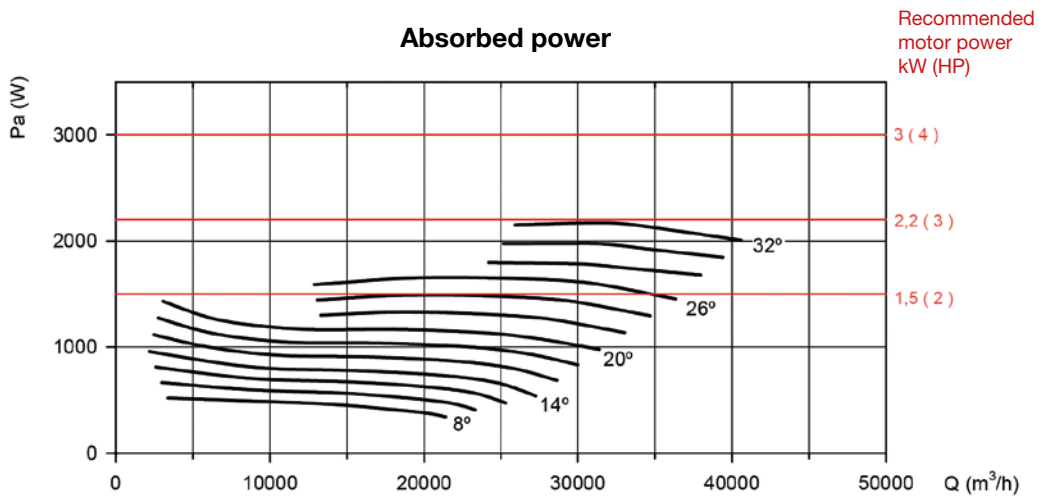

Characteristic curves

Q= Flow rate in m³/h, m³/s and cfm Pe= Static pressure in mm H₂O, Pa and inwg

Impeller diameter in cm: 125

Number of motor poles: 4

Number of blades: 6

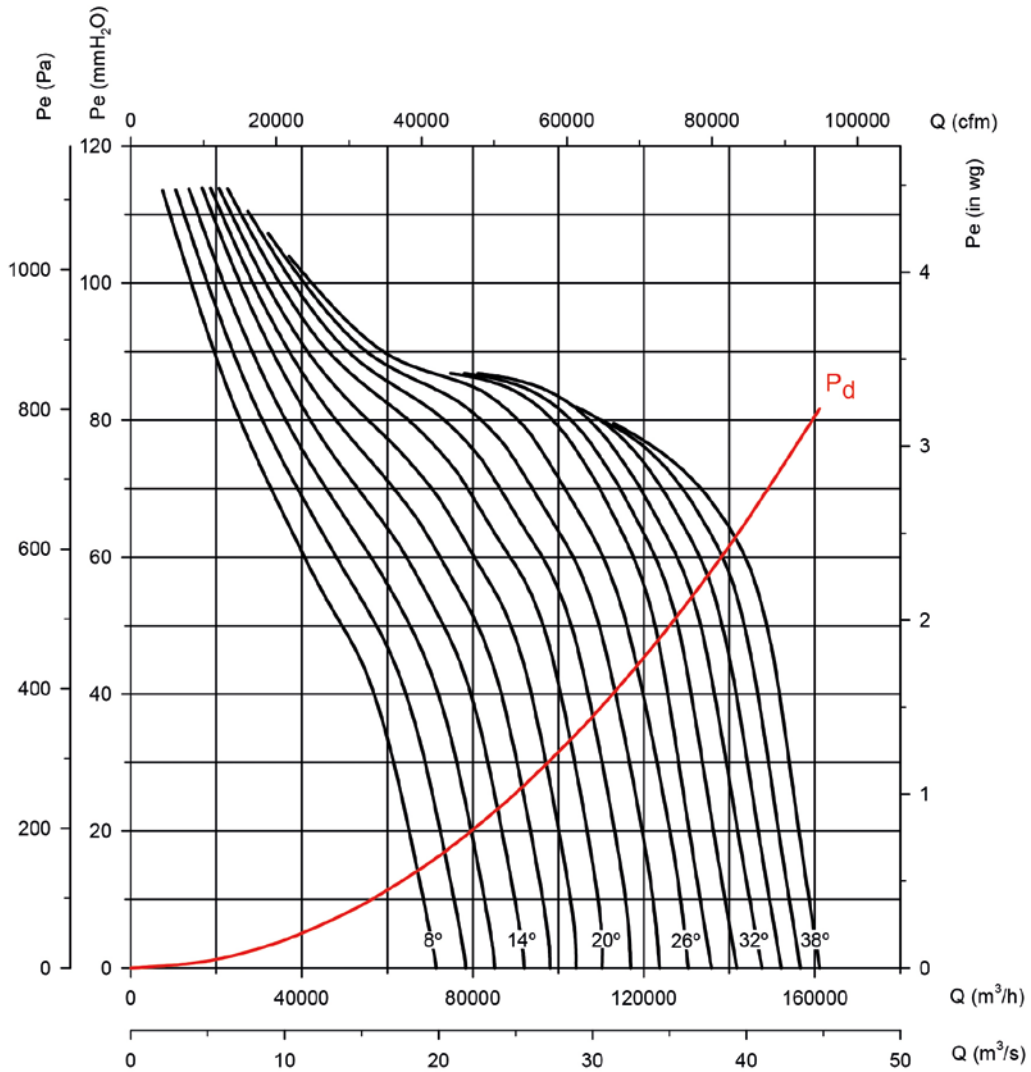

Absorbed power

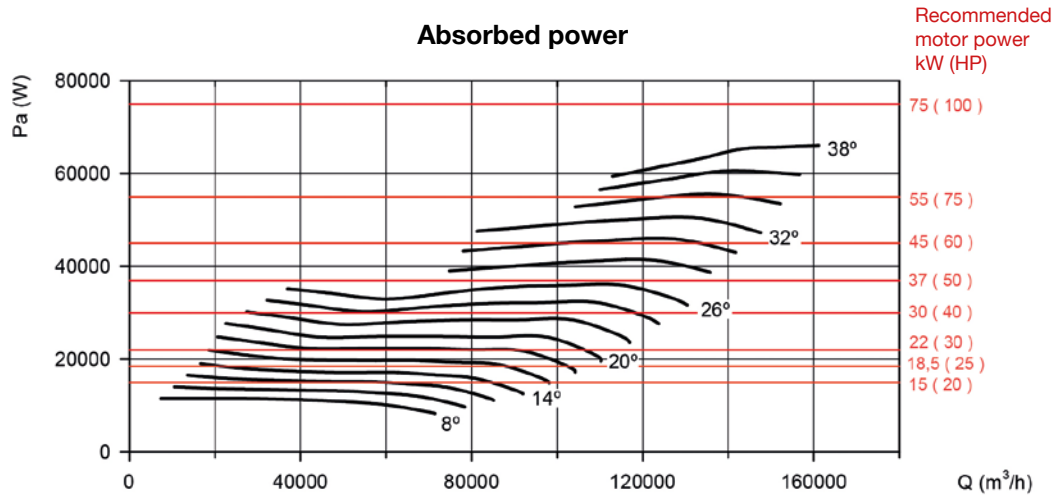

Characteristic curves

Q= Flow rate in m³/h, m³/s and cfm

Pe= Static pressure in mm H₂O, Pa and inwg

Impeller diameter in cm: 125

Number of motor poles: 4

Number of blades: 9

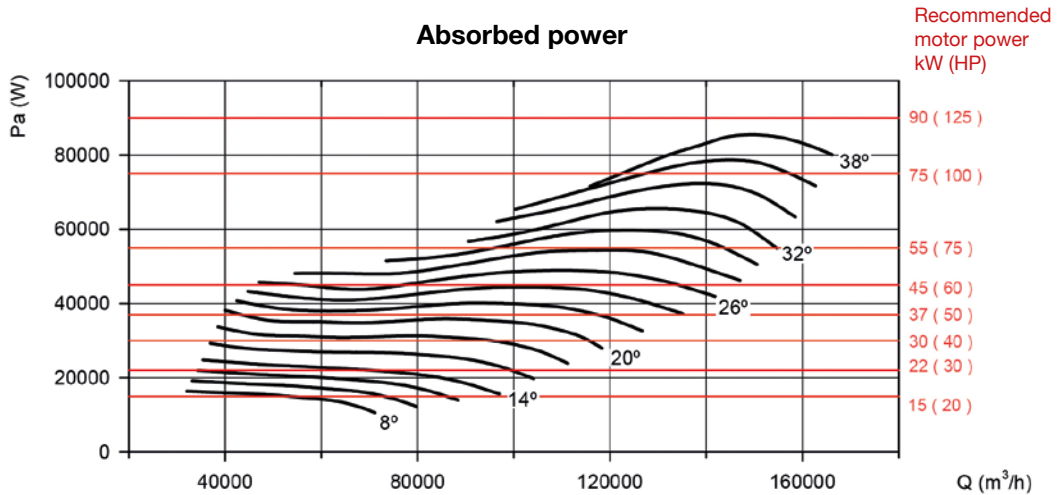
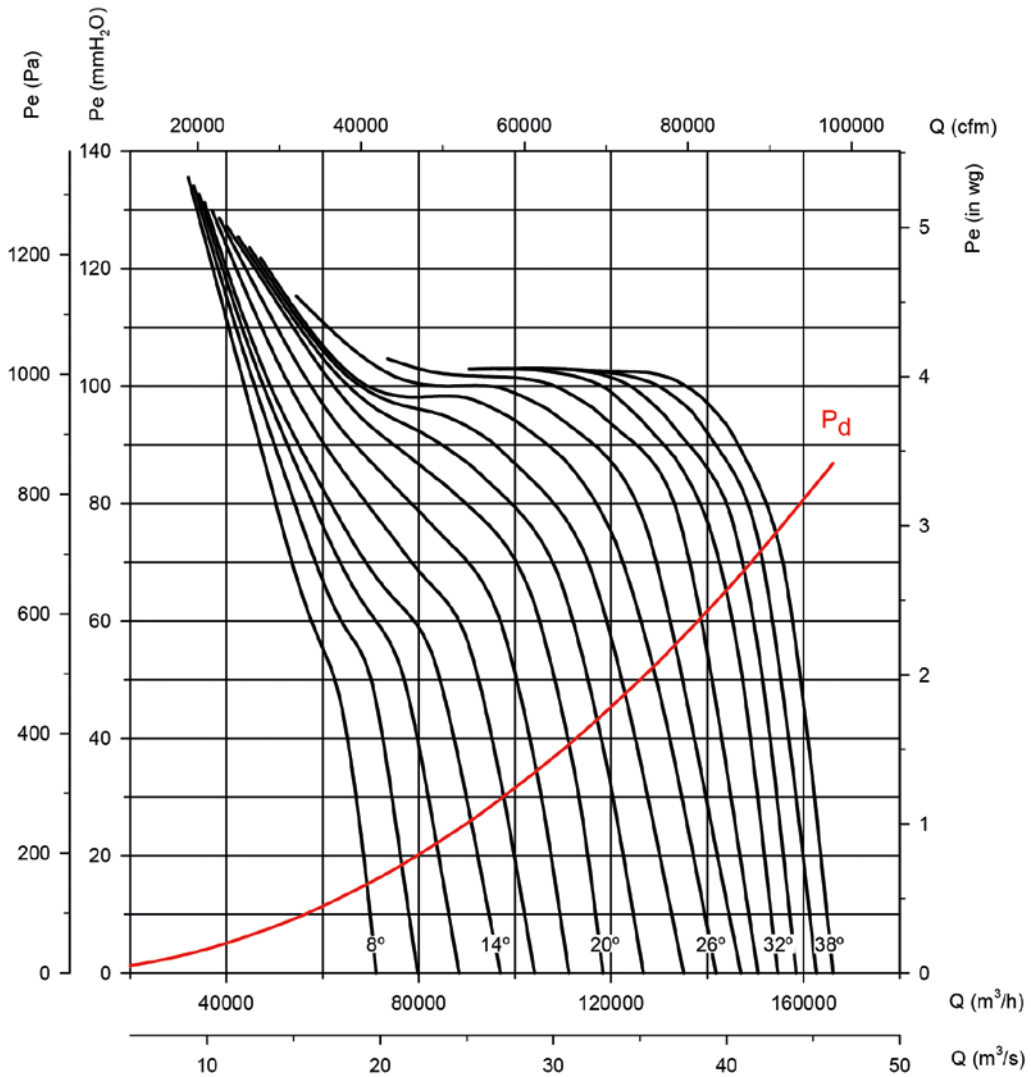

Characteristic curves

Q= Flow rate in m³/h, m³/s and cfm Pe= Static pressure in mm H₂O, Pa and inwg

Impeller diameter in cm: 125

Number of motor poles: 4

Number of blades: 12

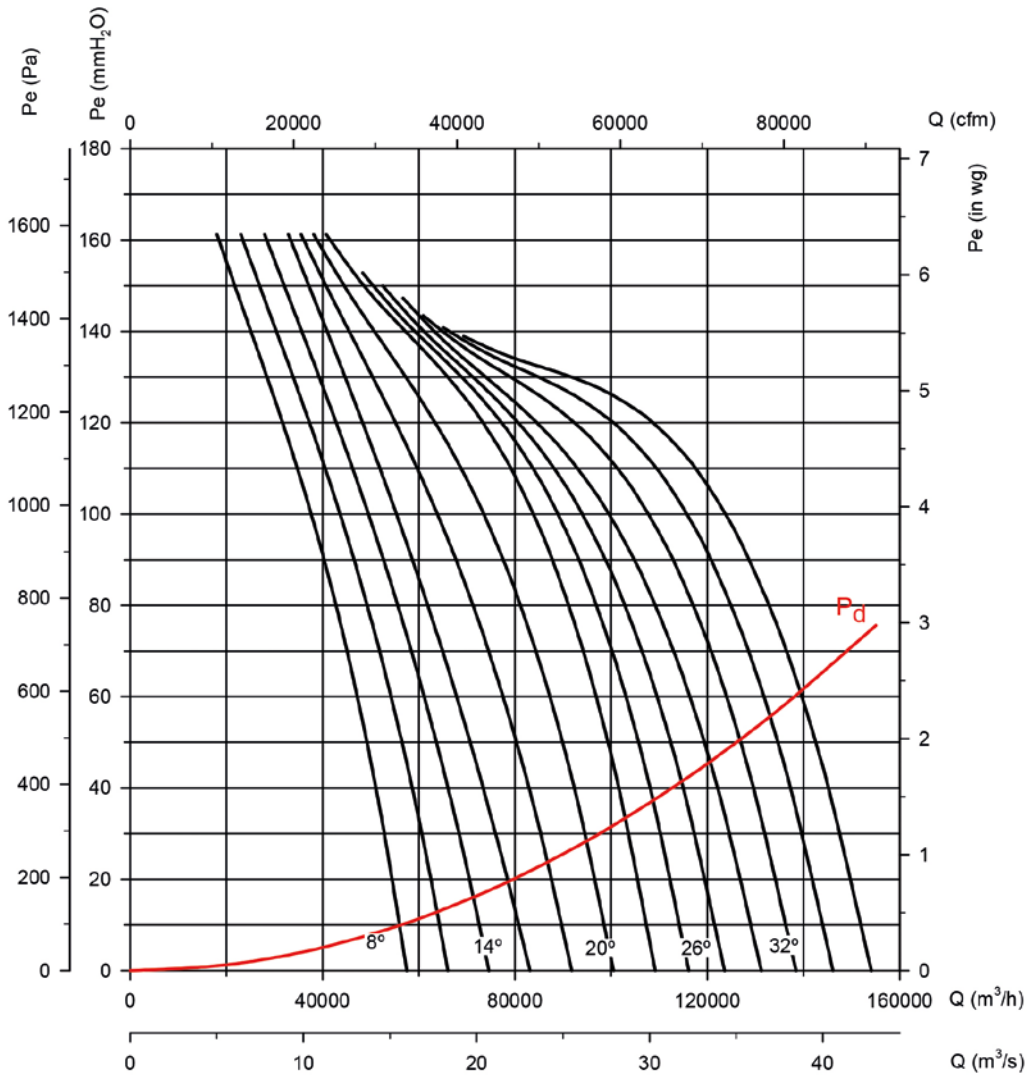

Absorbed power

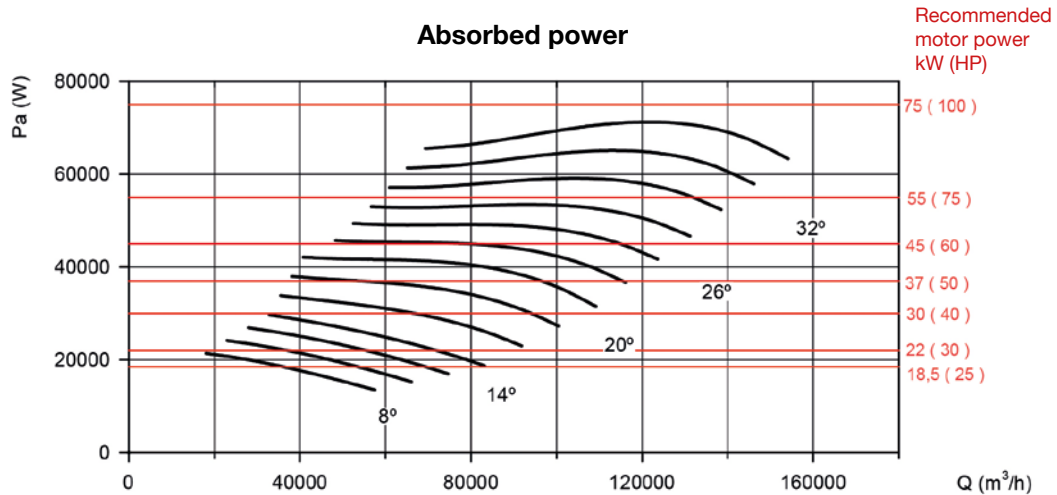

Characteristic curves

Q= Flow rate in m³/h, m³/s and cfm Pe= Static pressure in mm H₂O, Pa and inwg

Impeller diameter in cm: 125

Number of motor poles: 6

Number of blades: 6

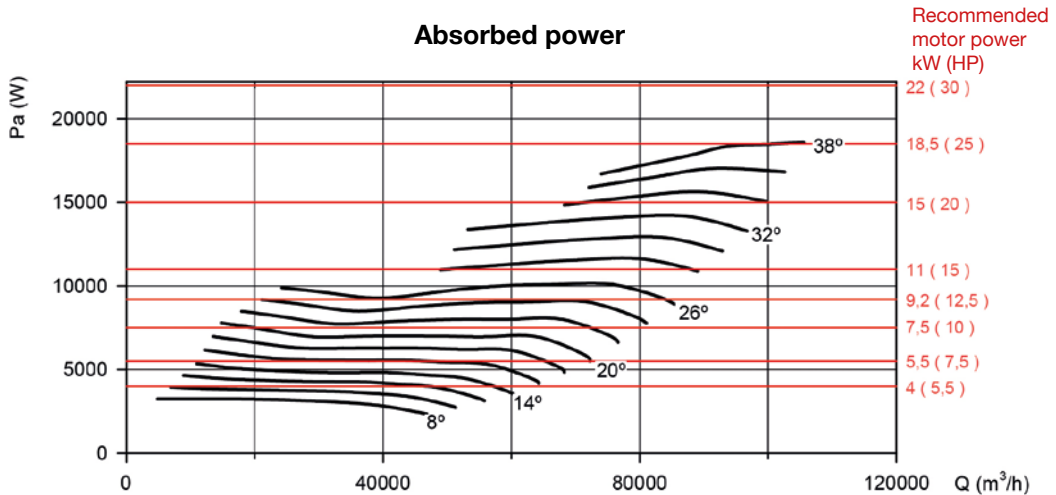
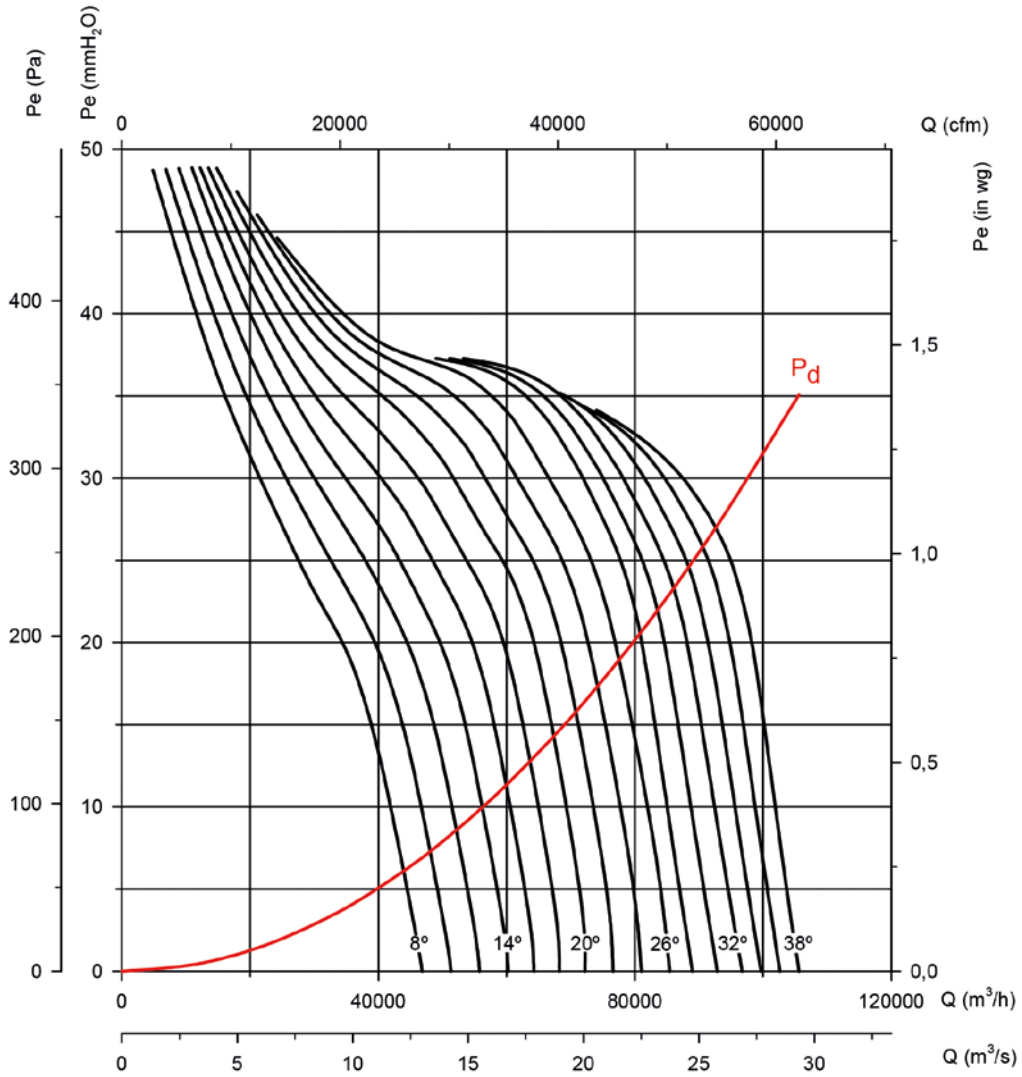

Characteristic curves

Q= Flow rate in m³/h, m³/s and cfm Pe= Static pressure in mm H₂O, Pa and inwg

Impeller diameter in cm: 125

Number of motor poles: 6

Number of blades: 9

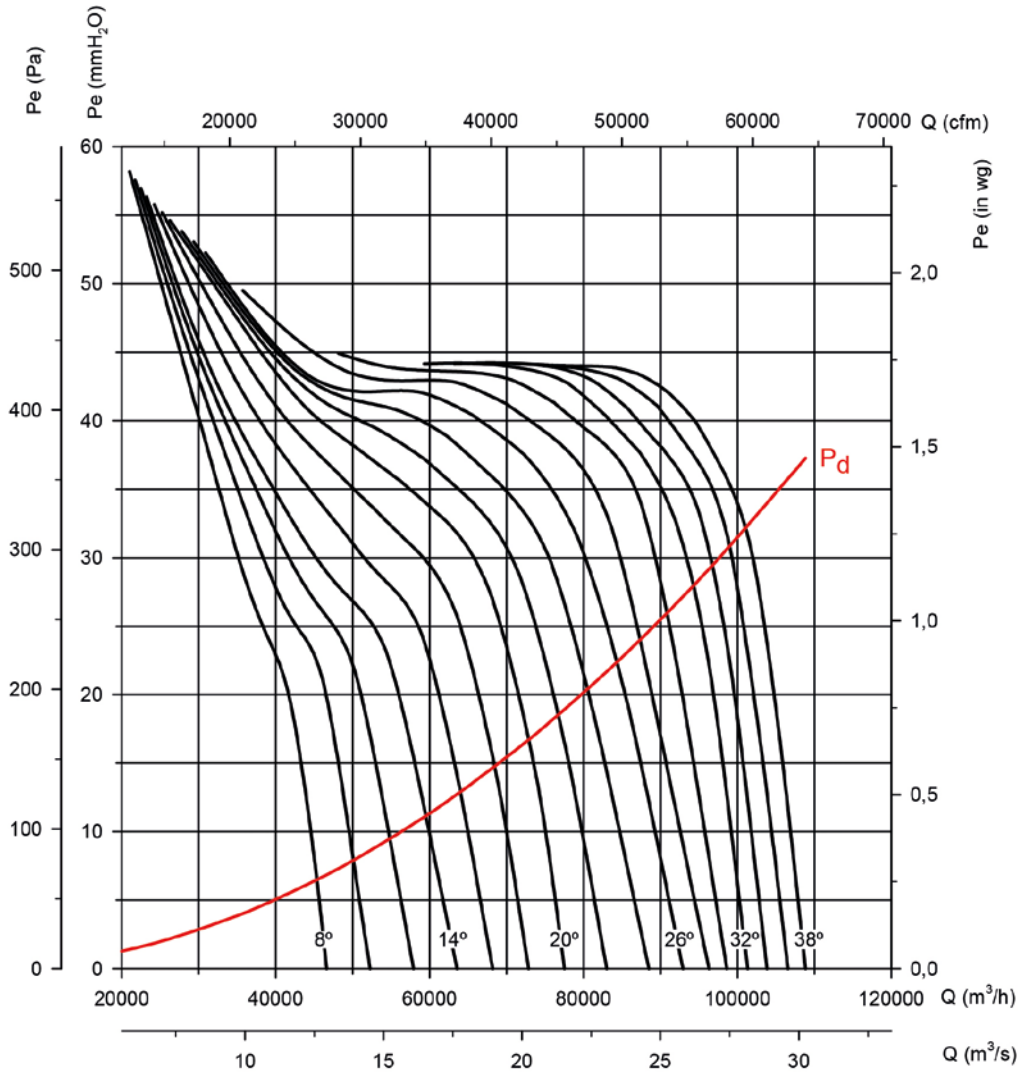

Absorbed power

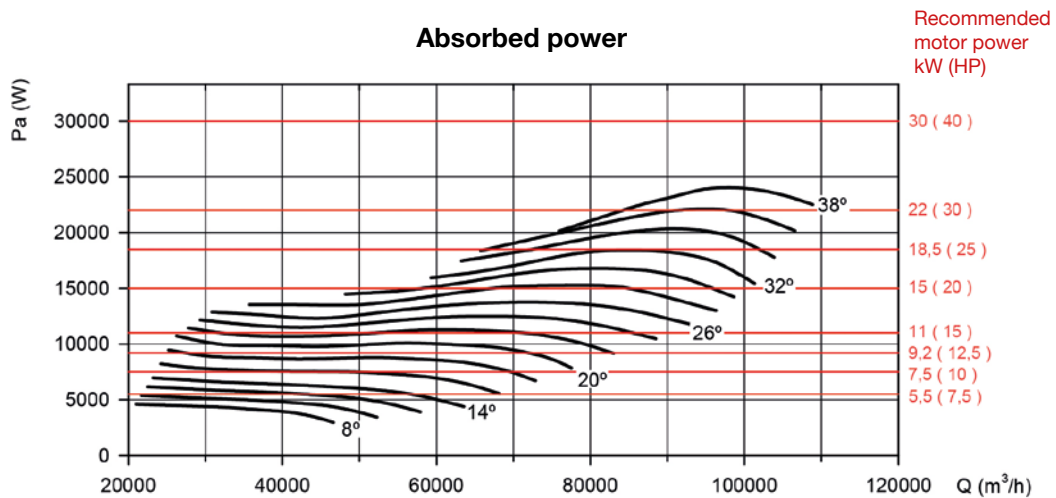

Characteristic curves

Q= Flow rate in m³/h, m³/s and cfm Pe= Static pressure in mm H₂O, Pa and inwg

Impeller diameter in cm: 125

Number of motor poles: 6

Number of blades: 12

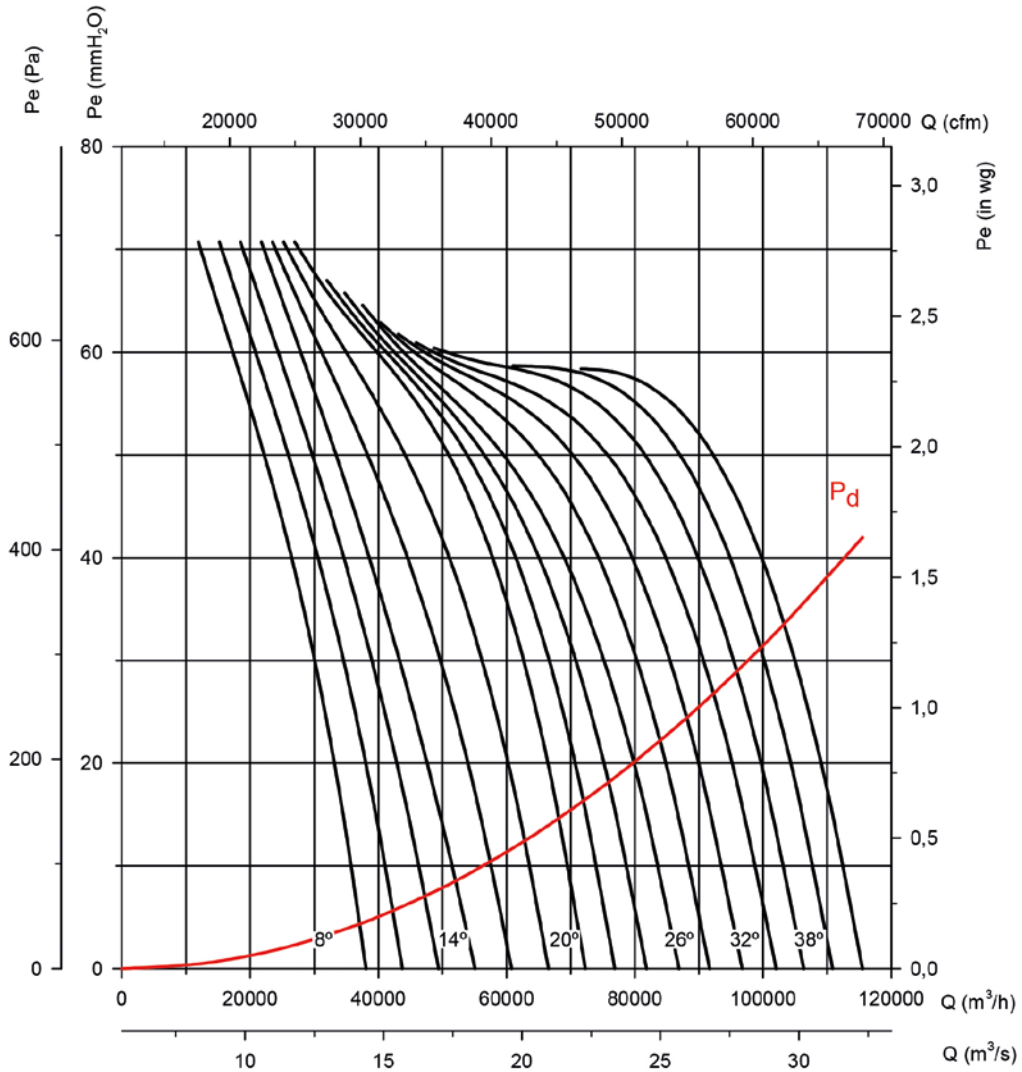

Absorbed power

Recommended motor power kW (HP)

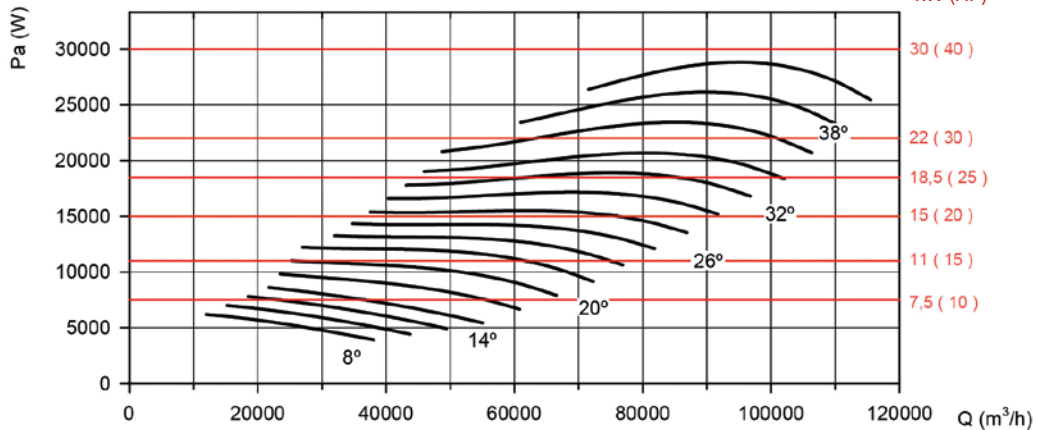

Characteristic curves

Q= Flow rate in m³/h, m³/s and cfm Pe= Static pressure in mm H₂O, Pa and inwg

Impeller diameter in cm: 140

Number of motor poles: 6

Number of blades: 6

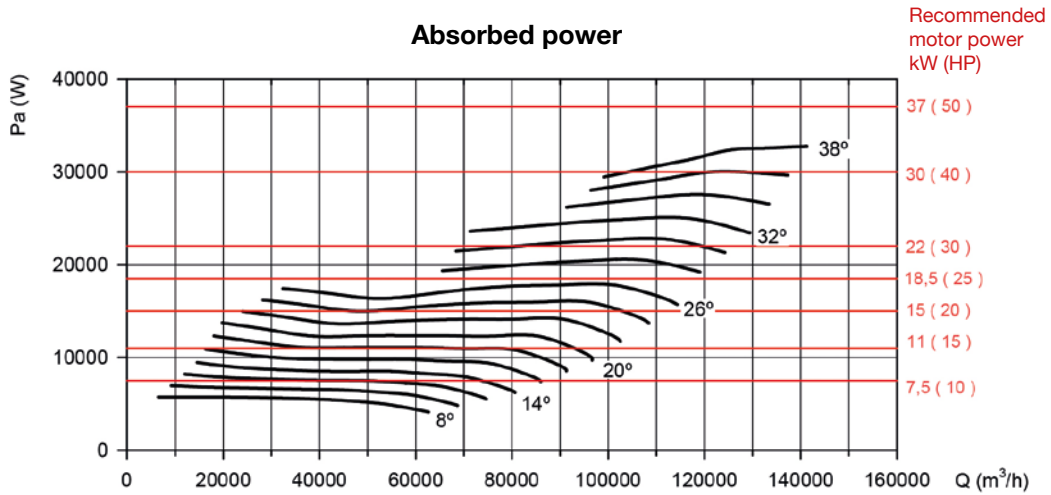
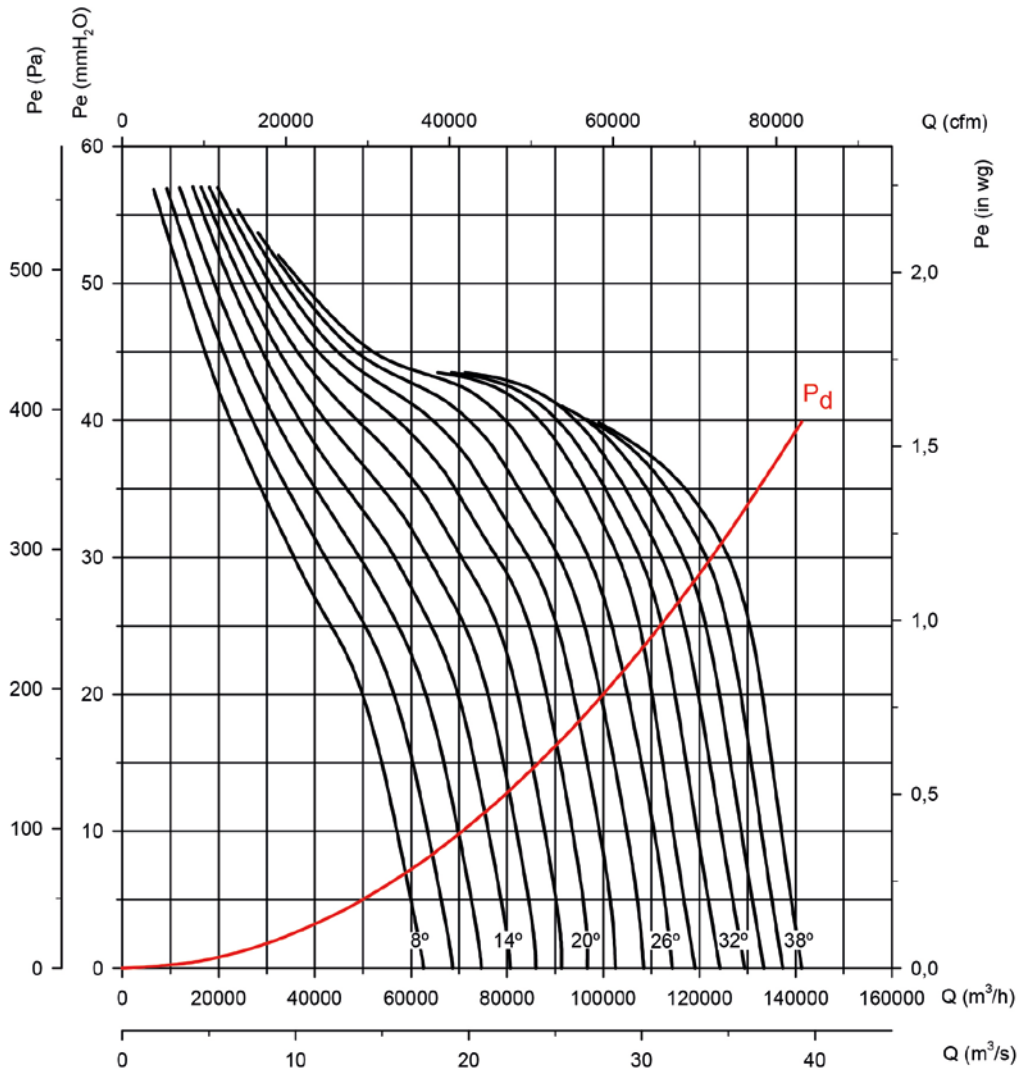

Characteristic curves

Q= Flow rate in m³/h, m³/s and cfm Pe= Static pressure in mm H₂O, Pa and inwg

Impeller diameter in cm: 140

Number of motor poles: 6

Number of blades: 9

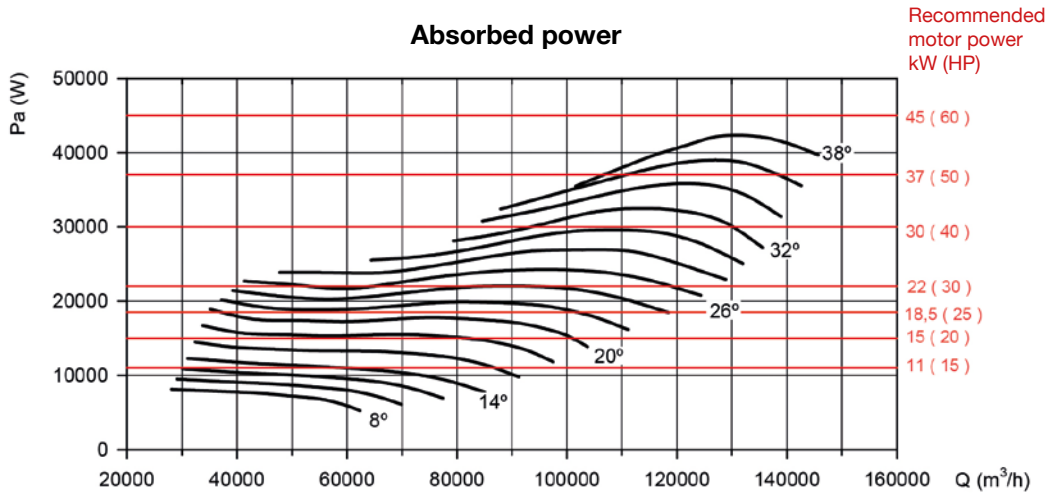
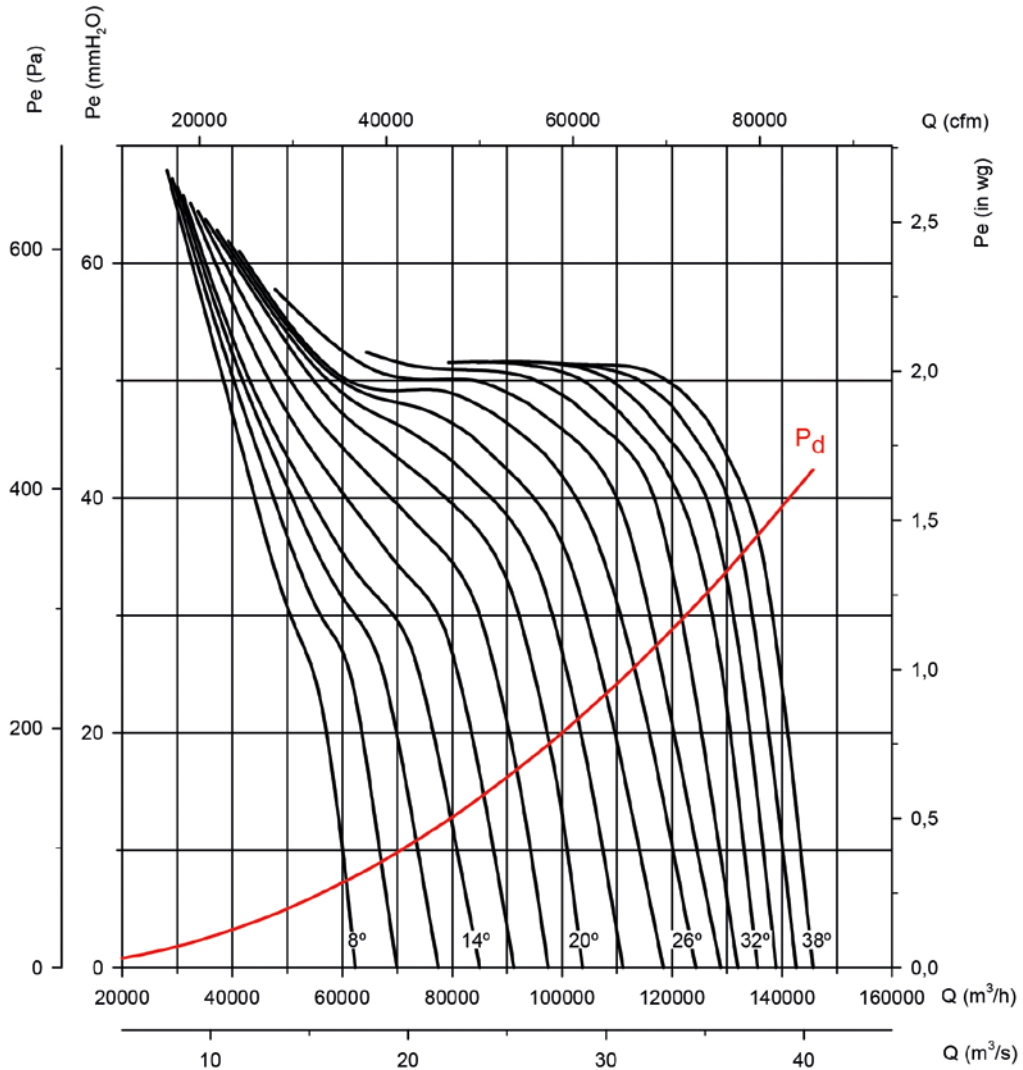

Characteristic curves

Q= Flow rate in m³/h, m³/s and cfm

Pe= Static pressure in mm H₂O, Pa and inwg

Impeller diameter in cm: 140

Number of motor poles: 6

Number of blades: 12

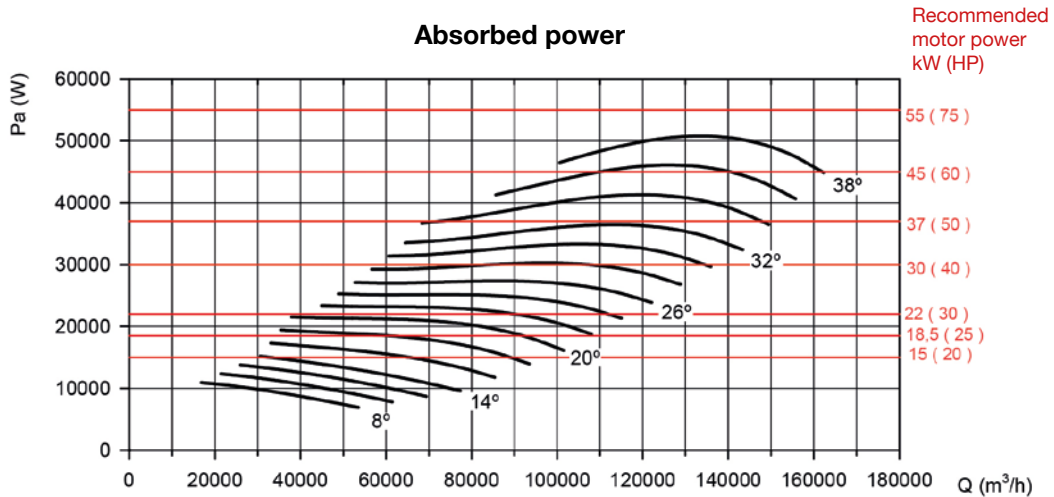
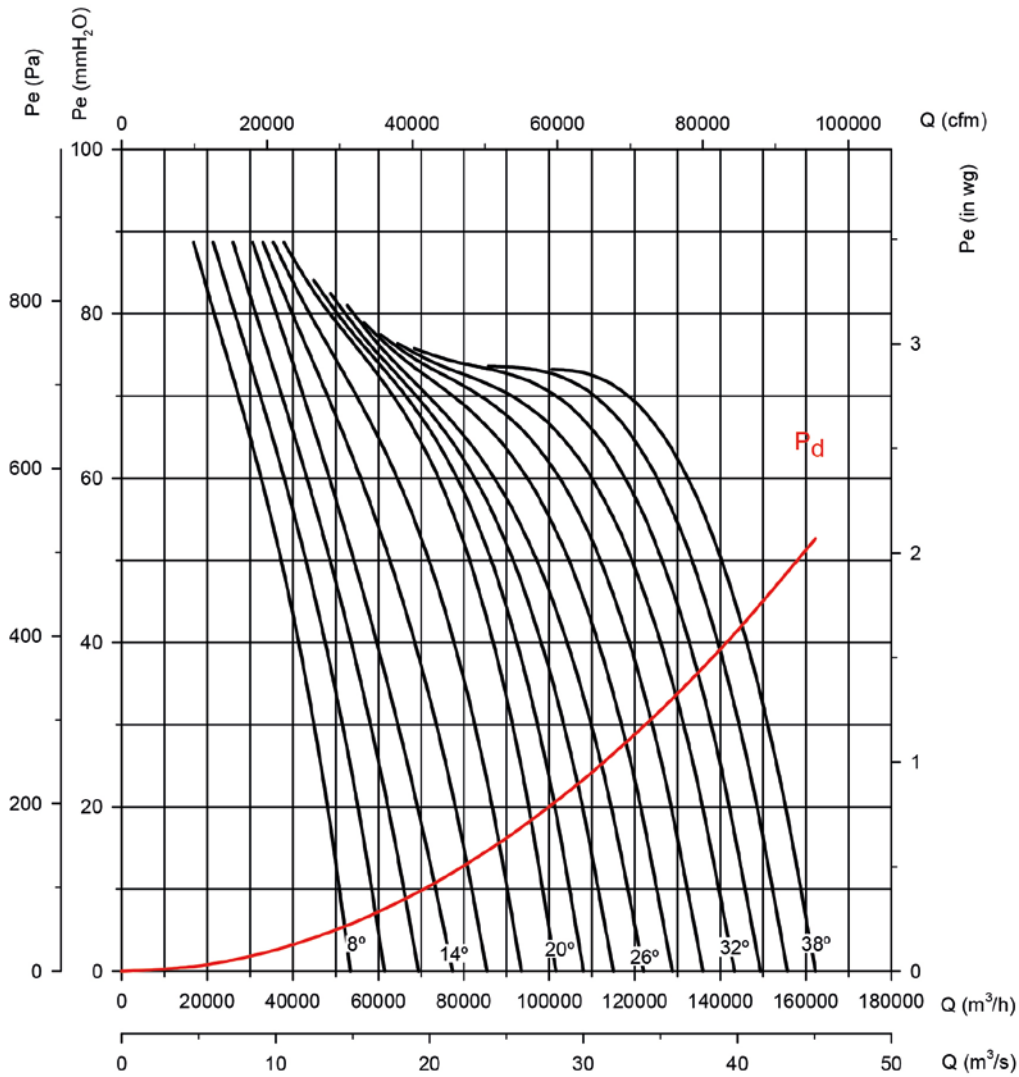

Characteristic curves

Q= Flow rate in m³/h, m³/s and cfm Pe= Static pressure in mm H₂O, Pa and inwg

Impeller diameter in cm: 160

Number of motor poles: 6

Number of blades: 6

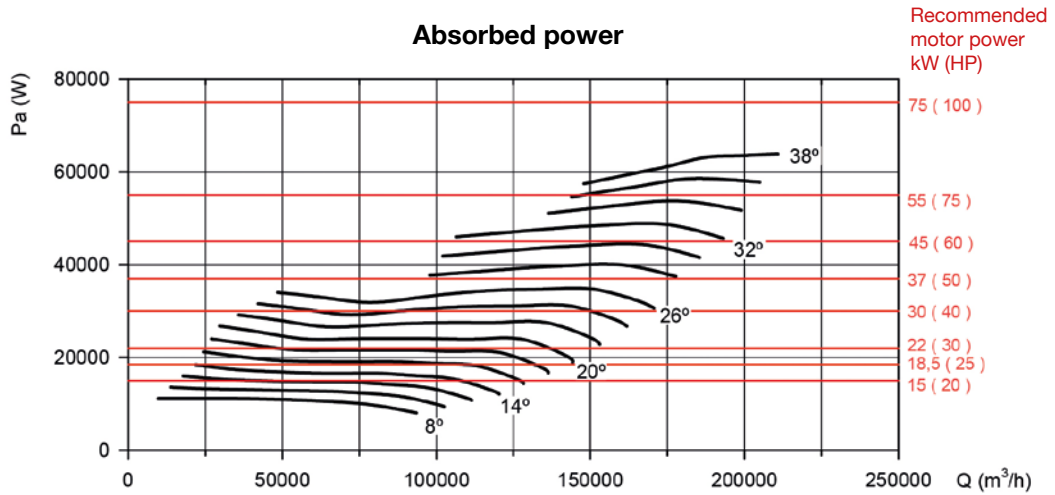
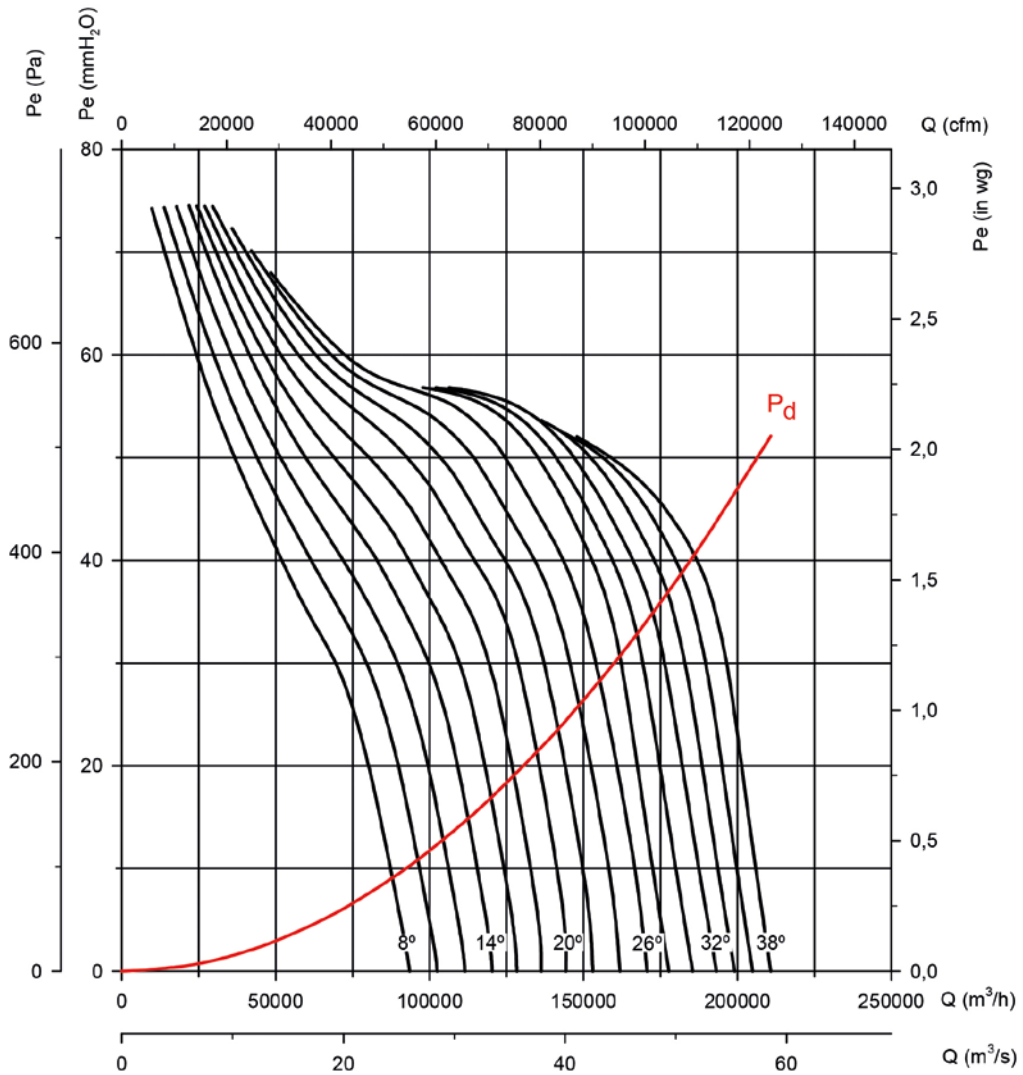

Characteristic curves

Q= Flow rate in m³/h, m³/s and cfm Pe= Static pressure in mm H₂O, Pa and inwg

Impeller diameter in cm: 160

Number of motor poles: 6

Number of blades: 9

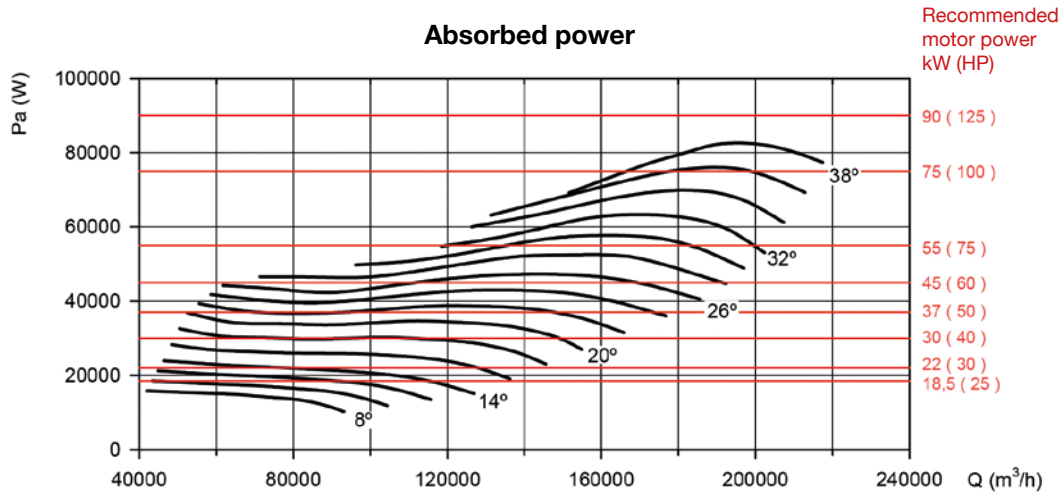
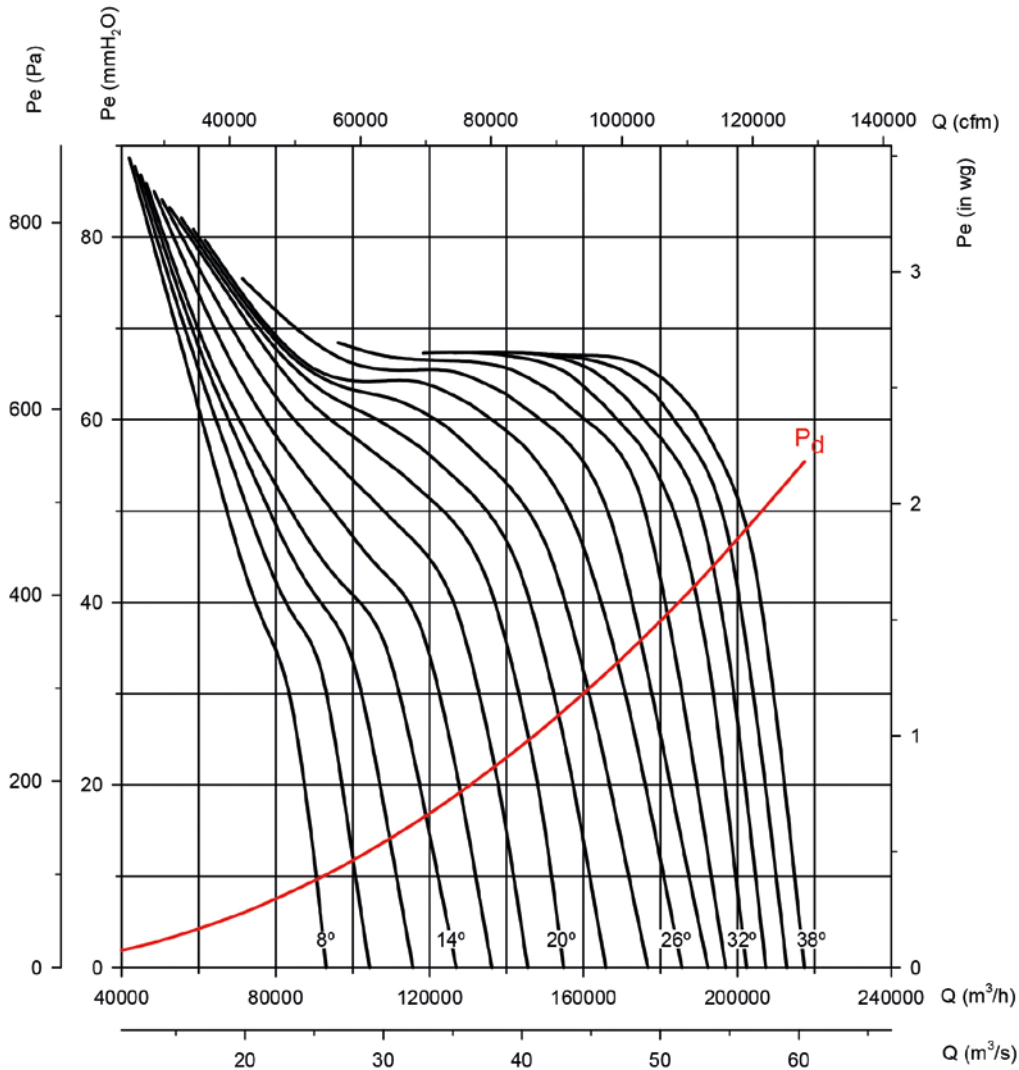

Characteristic curves

Q= Flow rate in m³/h, m³/s and cfm Pe= Static pressure in mm H₂O, Pa and inwg

Impeller diameter in cm: 160

Number of motor poles: 6

Number of blades: 12

